



Instrument Tube Fitting Installation Manual

Bulletin 4200-B4

May 2014

aerospace
climate control
electromechanical
filtration
fluid & gas handling
hydraulics
pneumatics
process control
sealing & shielding



ENGINEERING YOUR SUCCESS.

Installation

Tubing Fitting Installation

Tubing vs Pipe 1

Principles of Tube Line Fabrication..... 3

Instrument Tubing Selection Guide..... 19

Tubing Preparation
(handling, cutting, deburring, cleaning) 29

Assembly & Remake 32

Parker IPD Ferrule Presetting Tool..... 37

MPI™ Assembly & Remake 41

MPI™ Preset Tools 42

MPI™ Tubing Selection 44

Dielectric Fittings 48

High Integrity Coupling Assembly 49

Installation of Weld Fittings..... 50

Analytical Tube Fittings 56

Heat Code Traceability 58

Parker *Suparcase*® – Ferrule Hardening 60

Thread Identification 63

Thread and Tube End Size Charts 69

Pipe Data and Dimensions..... 77

Valves

Fittings

Tubing

Offer of Sale

The items described in this document are hereby offered for sale by Parker-Hannifin Corporation, its subsidiaries or its authorized distributors. This offer and its acceptance are governed by the provisions stated in the detailed "Offer of Sale" elsewhere in this document or available at www.parker.com/ipdus.

© 2014 Parker Hannifin Corporation. All rights reserved.



Parker Valves Overview

Needle Valves 79

Ball Valves 85

Check Valves 93

Metering Valves 105

Parker Fittings Overview

CPI™/A-LOK® Fittings 109

MPI Fittings..... 110

Pipe Fittings..... 111

Welded Fittings..... 112

Parker Tubing Overview 113

⚠ WARNING – USER RESPONSIBILITY

FAILURE OR IMPROPER SELECTION OR IMPROPER USE OF THE PRODUCTS DESCRIBED HEREIN OR RELATED ITEMS CAN CAUSE DEATH, PERSONAL INJURY AND PROPERTY DAMAGE.

This document and other information from Parker-Hannifin Corporation, its subsidiaries and authorized distributors provide product or system options for further investigation by users having technical expertise.

The user, through its own analysis and testing, is solely responsible for making the final selection of the system and components and assuring that all performance, endurance, maintenance, safety and warning requirements of the application are met. The user must analyze all aspects of the application, follow applicable industry standards, and follow the information concerning the product in the current product catalog and in any other materials provided from Parker or its subsidiaries or authorized distributors.

To the extent that Parker or its subsidiaries or authorized distributors provide component or system options based upon data or specifications provided by the user, the user is responsible for determining that such data and specifications are suitable and sufficient for all applications and reasonably foreseeable uses of the components or systems.

NOTICE: *The information contained within this publication is intended for educational purposes only. Information contained within is not intended for re-sale and may not be reproduced in whole or in part without the express written consent of The Parker Hannifin Corporation.*

Tubing vs. Pipe

Standard fluid line systems, whether for simple household use or for the more exacting requirements of industry, were for many years constructed from threaded pipe of assorted materials and were assembled with various standard pipe fitting shapes, unions and nipples. Such systems under high pressures were plagued with leakage problems besides being cumbersome, inefficient and costly to assemble and maintain. Therefore, the use of pipe in these systems has largely been replaced by tubing because of the many advantages it offers.

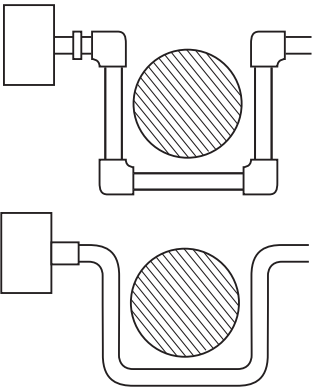

Old Method – Each connection is threaded – requires numerous fittings – system not flexible or easy to install and service connections not smooth inside – pockets obstruct flow.

Modern Method – Bendable tubing needs fewer fittings – no threading required – system light and compact – easy to install and service – no internal pockets or obstructions to free flow.

Figure 1 Tubing provides simplified, free flow system.

Major Advantages of Tubing vs. Pipe

- 1. Bending Quality** – Tubing has strong but relatively thin walls; is easy to bend. Tube fabrication is simple.
- 2. Greater Strength** – Tubing is stronger. No weakened sections from reduction of wall thickness by threading.

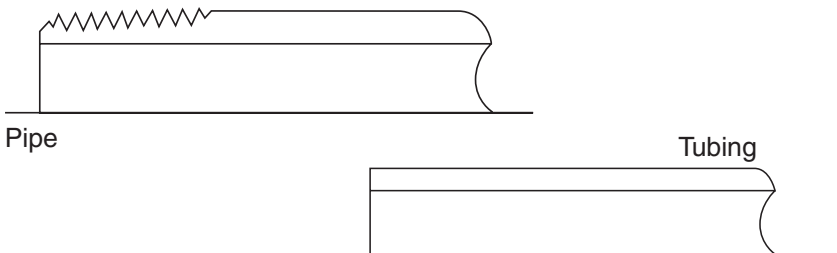

Figure 2 With no threading necessary, tubing does not require extra wall thickness

3. **Less Turbulence** – Smooth bends result in streamlined flow passage and less pressure drop.
4. **Economy of Space and Weight** – With its better bending qualities and a smaller outside diameter, tubing saves space and permits working in close quarters. Tube fittings are smaller and also weigh less.
5. **Flexibility** – Tubing is less rigid, has less tendency to transmit vibration from one connection to another.
6. **Fewer Fittings** – Tubing bends substitute for elbows. Fewer fittings mean fewer joints, fewer leak paths.
7. **Tighter Joints** – Quality tube fittings, correctly assembled, give better assurance of leak-free systems.
8. **Better Appearance** – Tubing permits smoother contours with fewer fittings for a professional look to tubing systems.
9. **Cleaner Fabrication** – No sealing compounds on tube connections. Again no threading; minimum chance of scale, metal chips, foreign particles in system.
10. **Easier Assembly and Disassembly** – Every tube connection serves as a union. Tube connections can be reassembled repeatedly with easy wrench action.
11. **Less Maintenance** – Advantages of tubing and tube fittings add up to dependable, trouble-free installations.

Principles of Tube Line Fabrication

1. Measure Exactly and Bend Accurately

Measuring exactly and bending accurately are the two most important rules which must be observed when fabricating a tube line.

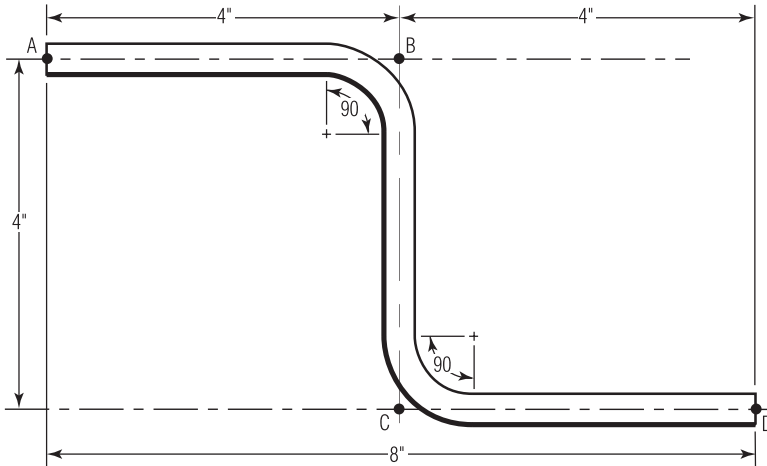

Figure 3 Accurate measurements coupled with exact angles may result in a tube line that will fit at points (A-D).

Exact measurement is required to insure that you obtain the desired distance between bends. If you do not measure exactly, the tube line will not fit.

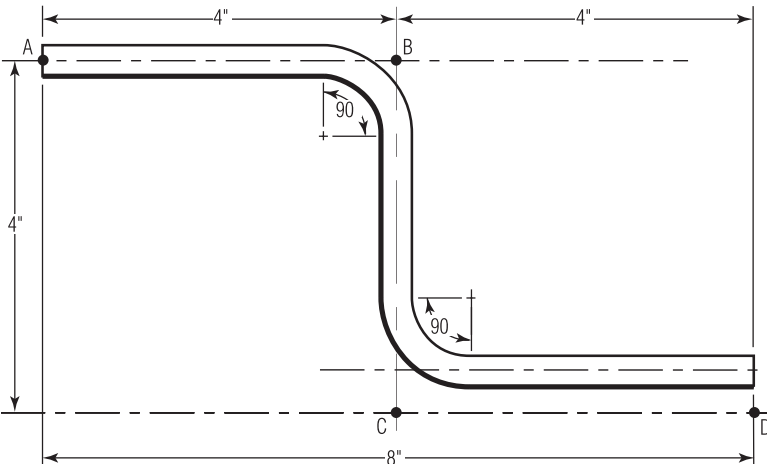

Figure 4 Measuring error on second leg (B-C) results in tube line that can not fit at point (D).

Accurate bending is necessary to achieve the exact angles required for the tube line. If you do not bend accurately, the tube line will not fit (Figure 5).

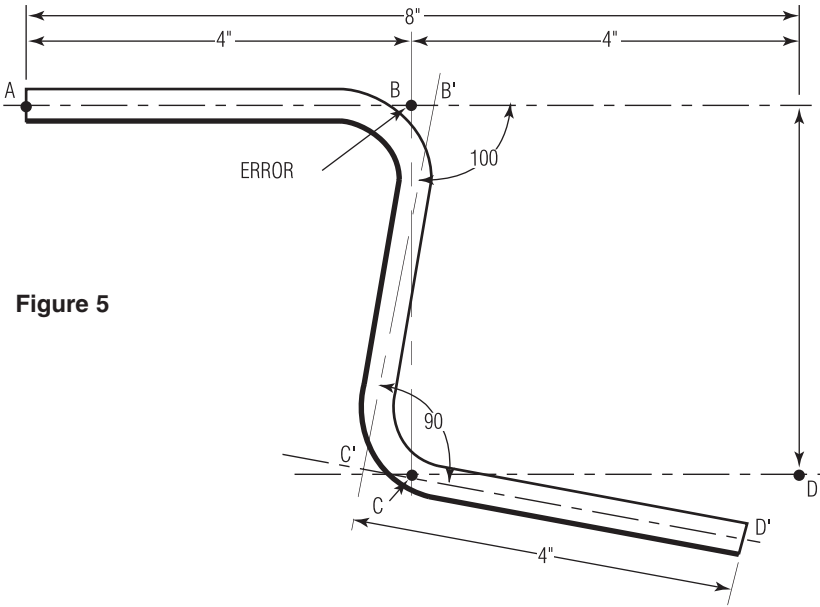

Figure 5

You must always measure exactly and bend accurately.

2. Tube Centerline Basis for Measurement

The centerline of the tube is the basis for all tube line measurement (Figure 6). Always measure from the centerline except from the first bend which is measured from the end of the tube. On most benders, the edge of the radius block is at the centerline of the tube.

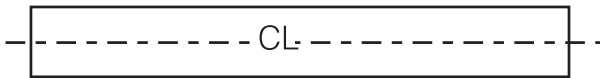

Figure 6

3. You Control Accuracy

Remember only you can control the accuracy of your work. Use good, careful workmanship at all times.

Tube Bending Checklist

Follow this list to insure good results on each bend.

1. Measure and mark exactly. Insert tube in bender.
2. Always try to bend in the same direction! If you backbend, be sure to compensate for gain or pickup. Remember, gain always occurs to the right side of the tube radius block.
3. Clamp tubing securely in bender.
4. Check to make certain length mark is tangent to desired angle on radius block or in line with the desired degree on the link member.
5. Bend accurately to the desired angle plus springback allowance.
6. Open bender, remove tube.
7. Double check bend angle with triangle.
8. Check measurement length with tape or ruler.

Keep Track of Changes of Plane

Benders bend in only one direction. Changes in plane are accomplished by rotating the tubing in the bender. To insure that the tubing is correctly placed for the desired change in plane, a reference mark on the tube is very helpful.

Bend Direction Mark

One method for keeping track of changes in plane is to use a longitudinal or length-wise bend direction mark (Figure 7).

Put the mark on the side opposite the direction in which you wish to bend.

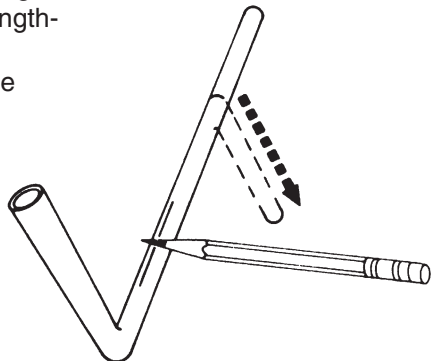

Figure 7

When you put the tube in the bender, center the mark face up in the groove of the radius block (Figure 8). This will insure that you bend in the correct direction. It also gives you a reference mark in case you must leave your work unfinished.

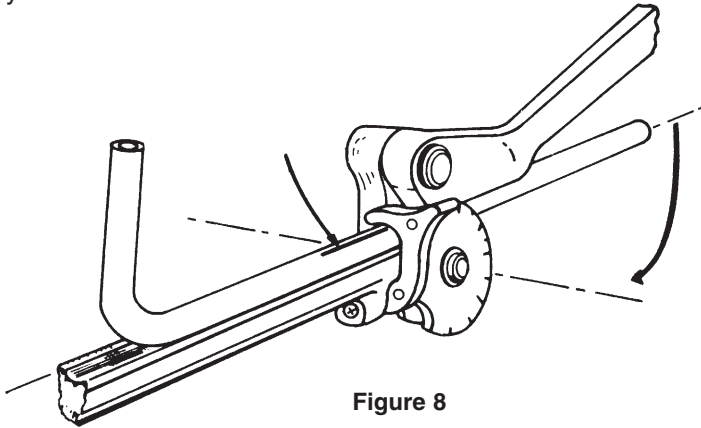

Figure 8

Marking the Tube

Whenever you make a mark on tubing, use a sharp pencil. Use a ferrule as a guide to make measurement marks all the way around the tube so that the mark is always visible (Figure 9). Don't use grease pencils or crayons as these make too wide a line which can easily affect accuracy.

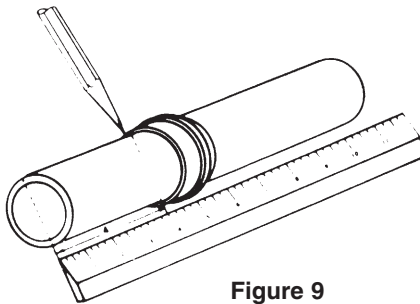

Figure 9

Measure and Mark

Never use a sharp tool to scratch marks onto tubing. Scratches create points where corrosion or stress concentration can ruin or dangerously weaken the tube.

Rules for Positioning Tubing in Bender

A line which is tangent to the desired angle mark on the radius block and which passes through the measurement mark at the centerline of the tube, is used to control the distance between bend centerlines (Figure 10).

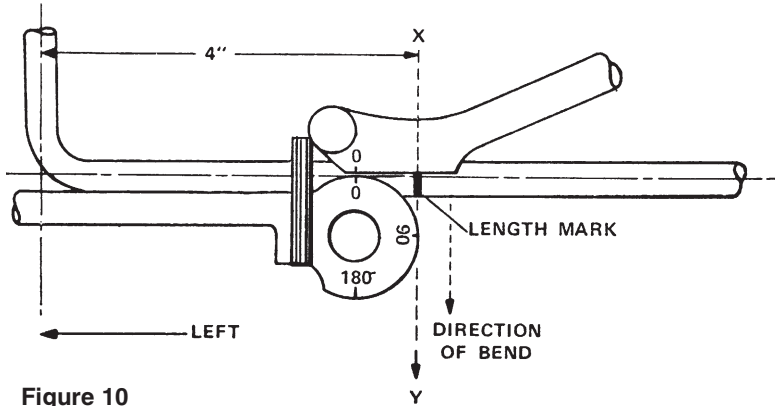
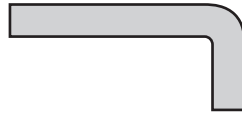

Figure 10

Tube Positioning Rules

90° angles – Tangent flush with length mark (refer to dotted line XY tangent to radius block @ 90°, Figure 10).



Angles less than 90° – Tangent intersects length mark at centerline.

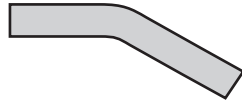

Angles more than 90° – Position for a 90° bend and continue on to desired angle, i.e., 135°, 145° (i.e., length mark @ 90° on link member).

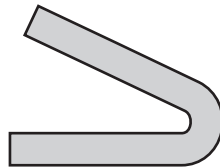

Horseshoe or U-Bends – Measure first leg, position for 90°, bend around to 180°.

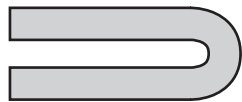

Springback 90° Bend

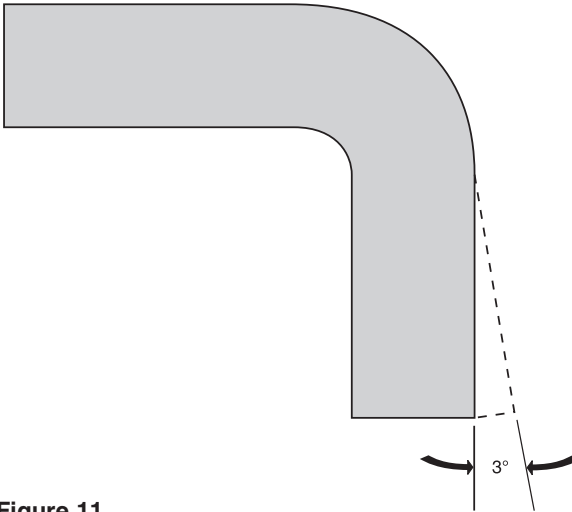

Figure 11

Rule of Thumb – Springback is approximately 3° for each 90° bend with stainless steel tubing.

Compensate for springback:

1. Test a piece of the material before you start fabricating a line to see how much it springs back on a 90° bend.
2. Overbend by the amount of springback. For example, if the material springs back 3° on a 90° bend, bend to 93° to secure a finished 90° bend, or to 46-1/2° to obtain finished 45° bend. This works especially well with large heavy-wall tubing.
3. Remember, it is always better to underbend slightly. You can always bend a little more if needed, but it's almost impossible to remove or straighten a bend, especially with large, heavy-wall tubing.

Remember – a tube bender bends – it cannot unbend.

Tube Stretch or Pickup

When bent, tubing seems to stretch or pick up length. This is because it takes a curved shortcut across the inside of the angle. A good “rule of thumb” for most standard tubing materials and radius blocks is that the tubing will stretch approximately one tube diameter for each 90° bend.

Triangle A-B-C – with Arc “A-C”

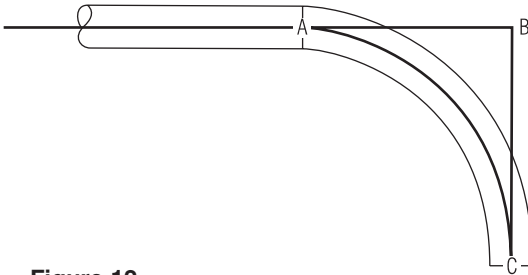

Figure 12

The arc “A-C” is shorter than the distance from “A” to “B”, plus “B” to “C”.

Always try to bend in the same direction – away from the original starting end. If you reverse the direction of bending (bending towards instead of away from the original starting end) you will “trap” the stretch. Thus, if you unknowingly make a reverse bend of 90°, you will trap the gain, in [Table 1](#) (approximately one tube O.D.) and increase your length between bends by that amount.

If bend direction for either 45° or 90° bend must be reversed, subtract the “gain” amount listed in [Table 1](#).

While our rule of thumb is approximately correct, the amount of stretch is related to the diameter of the radius block used. [Table 1](#) gives the accurate increase in length that occurs with the most commonly used sizes of radius blocks.

As long as you measure and bend with the tube inserted from the left, and measure centerline, “pickup” will not affect your actual center-to-center measurement.

Gain – 90° Bend

$$2R - \frac{\pi R}{2}$$

or

$$.429 R$$

$$\pi = 3.1416$$

$$R = \text{radius bender}$$

RADIUS BLOCK
DIAMETER OR
TUBE CENTER LINE

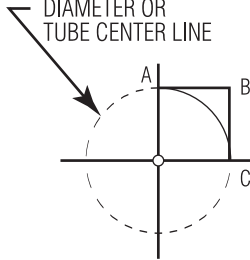

Gain – 45° Bend

$$8284R - \frac{\pi R}{4}$$

or

$$.043 R$$

Tube	Size	Radius of Bender (in inches)	Gain 90°	Gain 45°
1/8	2	3/8	.16	.02
3/16	3	7/16	.19	.02
1/4	4	9/16	.24	.02
5/16	5	11/16	.30	.03
3/8	6	15/16	.40	.04
1/2	8	1-1/2	.64	.06
5/8	10	1-7/8	.80	.08
3/4	12	2-1/4	.97	.10
7/8	14	2-5/8	1.13	.11
1	16	3	1.29	.13
1-1/4	20	3-3/4	1.61	.16
1-1/2	24	4-1/2	1.93	.19
2	32	*8	3.43	.34

Table 1

Pre-Measuring

You may pre-measure a series of bends. Measure the first bend from the end of the tube, the correct length. Compensate for each bend after the first by subtracting the amount of gain from your chart for each 90° of bend to allow for stretch (Figure 13). Always custom measure for the last bend.

Example of 1/4" Tubing

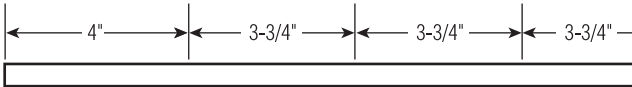

Figure 13

“Rule of Thumb” Method

Compensate each measurement after the first by subtracting the gain listed in [Table 1](#).

Best Way to Measure

For maximum accuracy, measure and bend exactly for each individual bend in the tubing line. We recommend the practice of Measure and Bend, Measure and Bend, etc.

Characteristics of a Well-Made Tubing Circuit

In a well made tubing circuit or line, bends are accurate, measurement exact. The run is plumb, square and level. Tube ends rest firmly in the fittings and entry into the fittings is straight. Straight tube entry is very important to insure that fittings are not under stress and can be assembled without leaks ([Figure 14](#)).

Remember too, that length magnifies bend angles errors. If the leg following the bend is fairly long, an error of 1° may result in the tube line missing the desired point completely.

Properly Made Tube Circuit

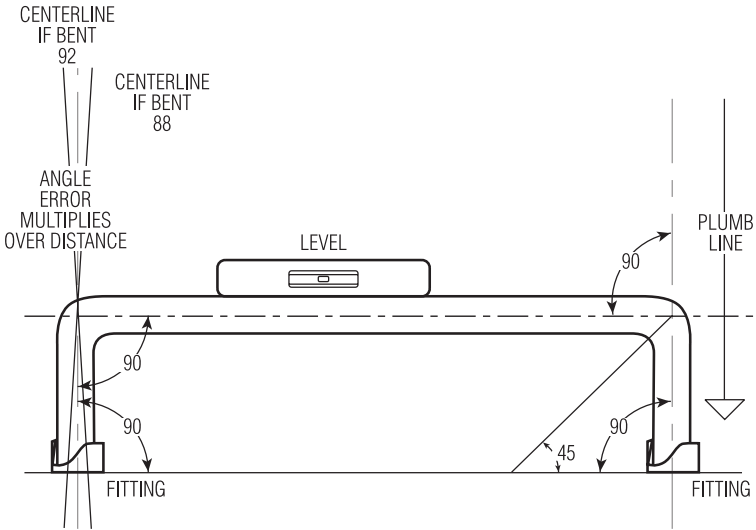

Figure 14

Recommended Free Tubing Lengths

It is important to consider the length of tubing from the end in the fitting body to the beginning of the bend.

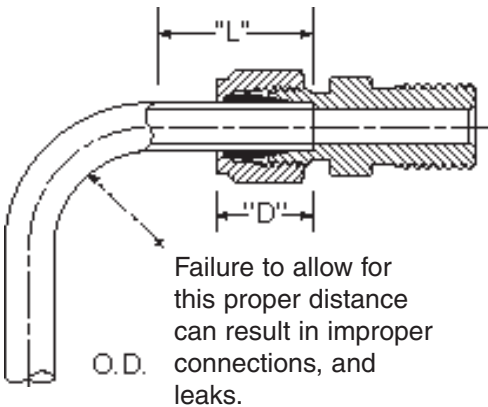

Figure 15

Tube O.D.*	L Free Length of Straight Tubing*	D Tube Insertion Depth*
1/16	0.50	0.38
1/8	0.70	0.52
3/16	0.75	0.56
1/4	0.80	0.61
5/16	0.88	0.66
3/8	0.94	0.69
1/2	1.19	0.94
5/8	1.25	0.98
3/4	1.25	0.98
7/8	1.31	1.05
1	1.50	1.22
1-1/4	1.94	1.61
1-1/2	2.41	1.96
2	3.25	2.65

Table 2

*All dimensions in inches.

Common Causes of Imperfect Bends

Figure 16 shows an ideal bend. Bends with little or no flattening are produced when correct equipment and methods are employed; when proper consideration is given to co-relationship of the radius of the bend, material wall thickness and hardness of the tube.

Figure 17 shows a flattened bend, caused by trying to bend too short a radius, or bending smaller diameter tube in larger radius block.

Figure 18 shows a kinked and flattened bend, caused by the tube slipping in the bender, or by using non-annealed tubing. Tubes must be firmly clamped by clamp block to prevent slippage during bending process.

Figure 19 shows a wrinkled bend, sometimes produced when thin wall tube is bent.

Breakage will sometimes occur when mandrel is too far forward in tube, or when too short a radius is attempted with hard tube.



Figure 16 Good Bend

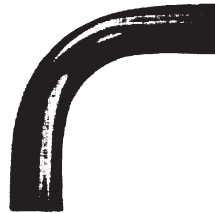

Figure 17 Flattened Bend



Figure 18 Kinked Bend



Figure 19 Wrinkled Bend

Offset Bends

To form a tube offset, it is obviously necessary to make two bends. With these Parker hand tube benders, it is easy to make double 45° bends. To make an offset bend simply follow the “Offset Bend Allowance” steps below to determine the proper distance between the two 45° bends. Here’s the procedure.

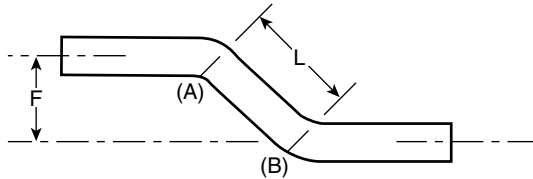

Figure 20

STEP 1 First, determine the total amount of offset required (dimension “F” in the diagram).

STEP 2 Next, determine the angle of offset – 30° or 45°. The latter (45°) is recommended because Parker hand benders are calibrated for 45° bending.

STEP 3 Figure the length of the tube required to meet your offset requirements (“L” dimension) in the diagram.

For 30° bends multiply desired offset “F” x 2 = 30° offset dimension “L”. For 45° bends multiply desired offset “F” x 1.414 = 45° offset dimension “L”.

STEP 4 Determine where you want the offset bend of the tube to start; and make a reference mark (A). Now measure off the “L” dimension (determined in Step 3), starting from the reference mark and make a second mark (B). You are now ready to make the bends.

STEP 5 Align mark (A) with reference mark 45° on bender shoe handle (measurement end to the left) and proceed with first bend. Then align (B) with 45° mark and make second bend in proper direction (measurement end to the left). Follow previous detailed instructions for making 45° bends in one plane.

Routing of Bends

Routing of lines is probably the most difficult yet most significant of these system design considerations. Proper routing involves getting a connecting line from one point to another through the most logical path. The most logical path should:

Avoid excessive strain on joints – A strained joint will eventually leak.

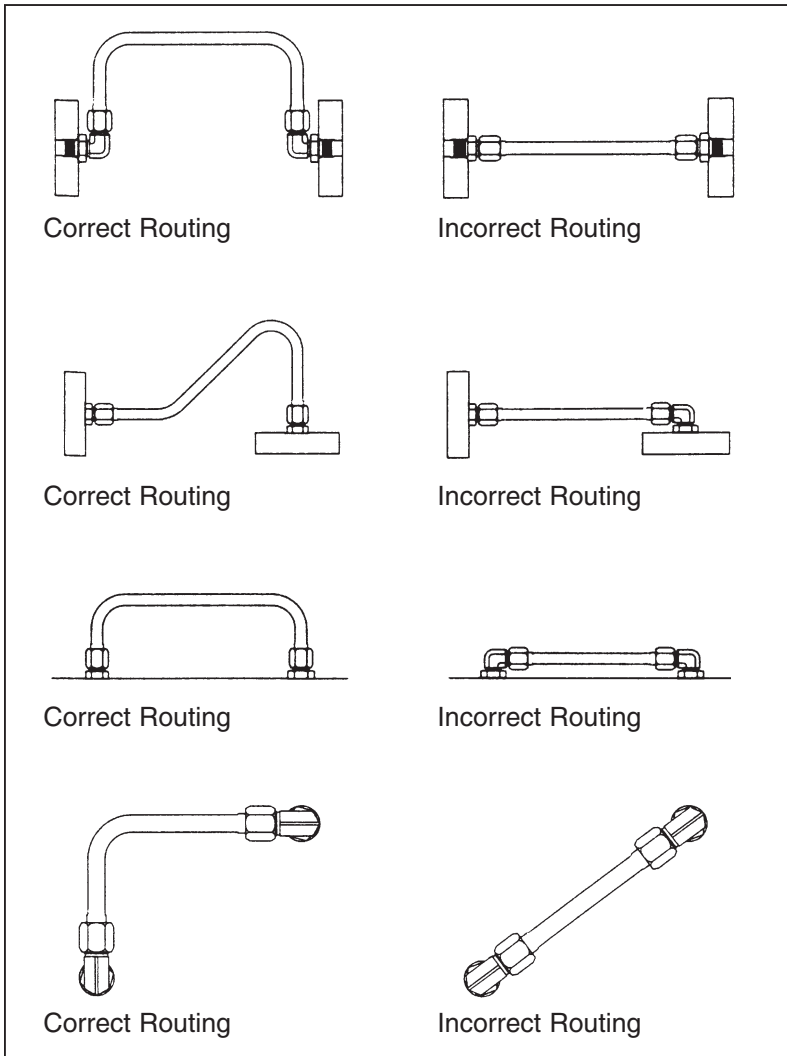

Figure 21

Allow for expansion and contraction – Use a “U” bend in long lines to allow for expansion and contraction.

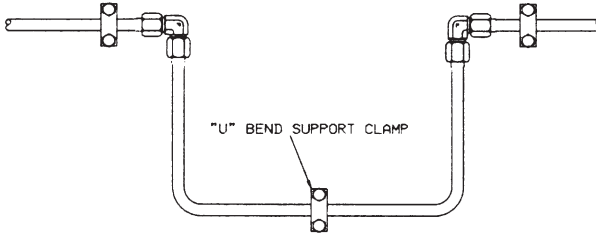

Figure 22 U-Bend Allowing for Expansion and Contraction

Allow for motion under load – Even some apparently rigid systems do move under load.

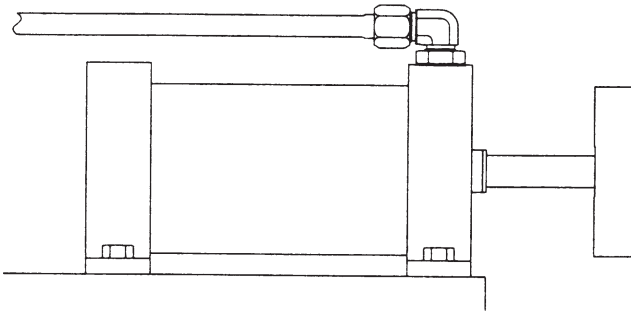
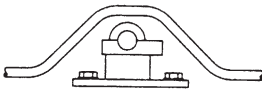
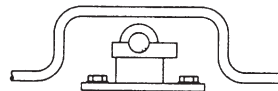

Figure 23 Bent Tube Allowing for Motion Under Load

Get around obstructions without using excessive amount of 90° bends. Pressure drop due to one 90° bend is greater than that due to two 45° bends.



Correct
Figure 24



Incorrect

Keep tube lines away from components that require regular maintenance.

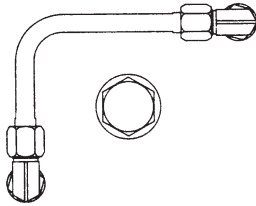

Correct
Figure 25

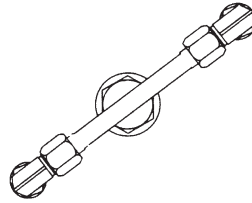

Incorrect

Have a neat appearance and allow for easy troubleshooting, maintenance and repair.

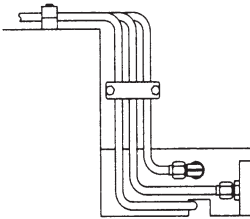

Correct
Figure 26

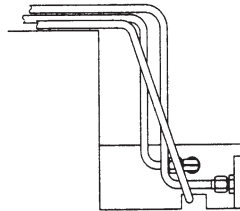

Incorrect

Tube Clamping

Once you've taken the time to make good bends and installed them, it's not enough to just let them lay suspended in mid-air. When tubing is left unsupported, shock and vibration will cause the tubing to shake, and in turn, cause the fitting to loosen and leak or even allow tube to fall through fatigue.

Tube support and clamping is a necessary requirement in the fluid power industry. Tubing can be clamped individually, in sets, and can also be stacked. The most important part of any clamping system is having enough clamps to attain the final result. That being, a well supported, vibration and noise free system.

Also, most manufacturers specify SAE and JIC approved components on their equipment. The best way to meet these specs concerning clamps is to utilize a clamp that employs both an upper and lower unit made of metal and a rubber split bushing which surrounds the tube or pipe and fits on the inside of the clamping units.

Parker Hannifin offers a tube clamp support system by the name of "ParKlamp". ParKlamp can clamp and support tube from 1/4" to 2" and pipe or hose from 1/4" to 1-1/2". It comes standard in steel and uses a rubber grommet around the tube for vibration dampening.

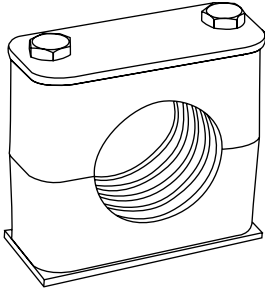

Standard Series –
for outside diameters from
1/4" to 2".
Clamp material: Polypropylene

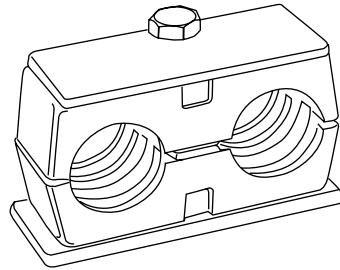

Twin Series –
for equal or unequal outside
diameters from 1/4" to 2"
Clamp Material: Polypropylene

Figure 27

Below you will find a chart of recommended spacing between clamps. We suggest you clamp as close to each bend of the tube as possible; and you must clamp each side. This eliminates thrust in all directions.

For further information, please refer to Bulletin 4300, Industrial Tube Fittings, Adapters and Equipment.

Tube O.D.	Equivalent Tube (mm)	Foot Spacing Between Supports	Spacing in Meters (Approx.)
1/4" – 1/2"	6 – 13 mm	3 ft.	0.9 m
3/8" – 7/8"	14 – 22 mm	4 ft.	1.2 m
1"	23 – 30 mm	5 ft.	1.5 m
1-1/4" & up	31 & up mm	7 ft.	2.1 m

Table 3

Overview

1. **Always Match Materials** – I.E., Stainless steel tubing should be used only with SS Fittings. The only exception to this rule is copper tubing with brass fittings. Mixing materials can cause galvanic corrosion.

Galvanic Corrosion (Electrochemical)

All metals have a specific relative electrical potential. When dissimilar metals come in contact in the presence of moisture (electrolyte), a low energy electric flows from the metal having the higher potential to the metal having the lower potential. The result of this galvanic action is the corrosion of the metal with the higher potential (more anodic). (See [Galvanic Series Chart on page 20.](#))

2. **Select proper tubing hardness** – Remember Parker Instrumentation Tube Fittings are designed to work within specific hardness ranges. Rb 90 max. for S.S., Rb 80 recommended.
3. **Select proper tubing wall thickness** – Proper wall thickness is necessary to accommodate accepted safety factors relative to desired working pressures. For details on items 2 & 3 note “Instrumentation Tubing Selection Guide” shown below and on the following pages.
4. **Tubing surface finish** – Always select tubing free of visible drawmarks or surface scratches. If possible, cut off any undesirable sections. These “deep” scratches can cause leaks when attempting to seal low-density gases such as argon, nitrogen, or helium.

Instrument Tubing Selection Guide

Parker’s instrument tube fittings have been designed to work in a wide variety of applications that demand the utmost in product performance.

Although Parker’s Instrument tube fittings have been engineered and manufactured to consistently provide this level of reliability, no systems integrity is complete without considering the critical link, tubing.

This booklet is intended to assist the designer to properly select and order quality tubing.

Proper tube selection and installation, we believe, are key ingredients in building leak-free reliable tubing systems.

Parker does not recommend the use of dissimilar metals when putting together a tubing/ fitting connection system.

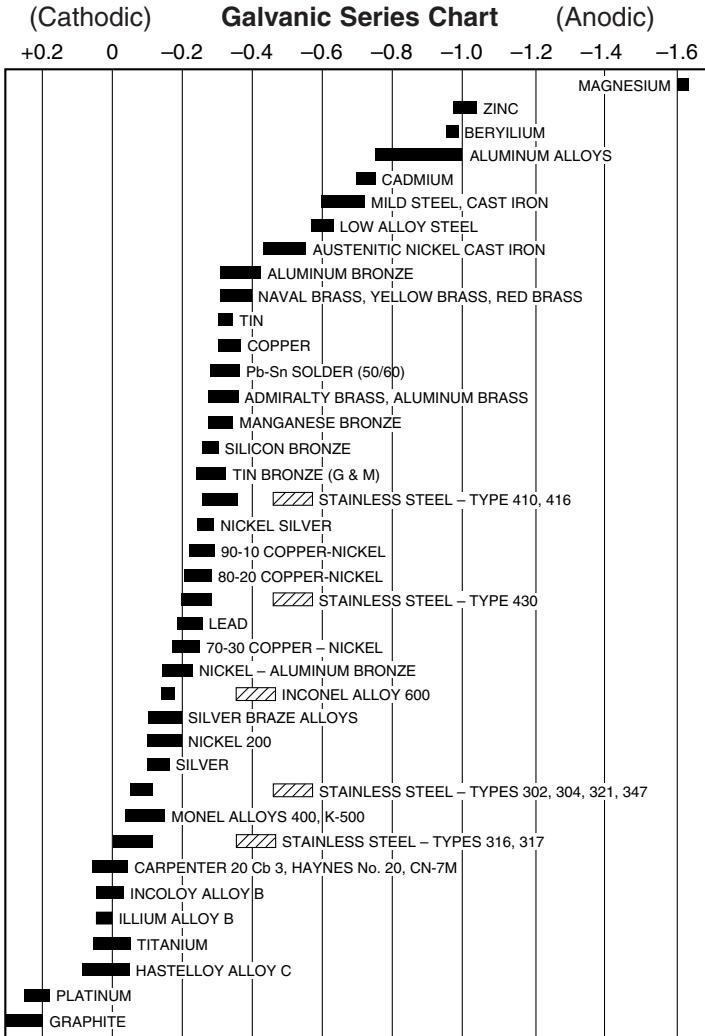

Above represents corrosion potentials of materials in flowing seawater at temperature in the range 10°C – 26°C. The hatched symbols indicate potentials exhibited by stainless steels in pits or crevices.

Figure 28 Galvanic Series Chart

General Selection Criteria

The most important consideration in the selection of suitable tubing for any application is the compatibility of the tubing material with the media to be contained. Table 4 lists common materials and their associated general application. Table 4 also lists the maximum and minimum operating temperature for the various tubing materials.

In addition, Parker instrument fittings are designed to work on like materials. Stainless steel fittings should be used only with stainless steel tubing, aluminum fittings with aluminum tubing, etc. The practice of mixing materials is strongly discouraged. The only exception is brass fittings with copper tubing.

Dissimilar materials in contact may be susceptible to galvanic corrosion. Further, different materials have different levels of hardness, and can adversely affect the fittings ability to seal on the tubing.

Table 4

Tubing Material	General Application	Recommended Temperature Range
Stainless Steel (Type 316)	High pressure, high temperature, generally corrosive media	-425°F to 1,200°F ¹ (-255°C to 605°C)
Carbon Steel	High pressure, high temperature oil, air, some specialty chemicals	-20°F to 800°F ² (-29°C to 425°C)
Copper	Low temperature, low pressure water, oil, air	-40°F to 400°F (-40°C to 205°C)
Aluminum	Low temperature, low pressure water, oil, air, some specialty chemicals	-40°F to 400°F (-40°C to 205°C)
Monel® 400	Recommended for sour gas applications well suited for marine and general chemical processing applications	-325°F to 800°F (-198°C to 425°C)
Hastelloy® C-276	Excellent corrosion resistance to both oxidizing and reducing media and excellent resistance to localized corrosion attack	-325°F to 1000°F (-198°C to 535°C)
Carpenter® 20	Applications requiring resistance to stress corrosion cracking in extreme conditions	-325°F to 800°F (-198°C to 425°C)
Inconel® Alloy 600	Recommended for high temperature applications with generally corrosive media	-205°F to 1200°F (-130°C to 650°C)
Titanium	Resistant to many natural environments such as sea water, body fluids and salt solutions	-75°F to 600°F (-59°C to 315°C)

- For operating temperatures above 800°F (425°C), consideration should be given to media. 300 Series Stainless Steels are susceptible to carbide precipitation which may lead to intergranular corrosion at elevated temperatures.
- Consideration should be given to maximum temperature ratings if fittings and/or tubing are coated or plated. All temperature ratings based on temperatures per ASME B31.3 Chemical Plant and Petroleum Refinery Piping Code, 1999 Edition.

The information listed in Table 4 is general in scope. For specific applications, please contact Parker's Instrumentation Products Division, Product Engineering Department (256) 881-2040.

Note: Hastelloy® is a registered trademark of Haynes International. Inconel®, and Monel® are registered trademarks of Special Metals Corporation. Carpenter® is a registered trademark of CRS Holdings Inc.

Gas Service

Special care must be taken when selecting tubing for gas service. In order to achieve a gas-tight seal, ferrules in instrument fittings must seal any surface imperfections. This is accomplished by the ferrules penetrating the surface of the tubing. Penetration can only be achieved if the tubing provides radial resistance and if the tubing material is softer than the ferrules.

Thick walled tubing helps to provide resistance. Tables 5 through 10 indicate the minimum acceptable wall thickness for various materials in gas service. The ratings in white indicate combination of diameter and wall thickness which are suitable for gas service.

Acceptable tubing hardness for general application is listed in [Table 12](#). These values are the maximum allowed by ASTM. For gas service, better results can be obtained by using tubing well below this maximum hardness. For example, a desirable hardness of 80 Rb is suitable for stainless steel. The maximum allowed by ASTM is 90 Rb.

System Pressure

The system operating pressure is another important factor in determining the type, and more importantly, the size of tubing to be used. In general, high pressure installations require strong materials such as steel or stainless steel. Heavy walled softer tubing such as copper may be used if chemical compatibility exists with the media. However, the higher strength of steel or stainless steel permits the use of thinner tubes without reducing the ultimate rating of the system. In any event, tube fitting assemblies should never be pressurized beyond the recommended working pressure.

The following tables (5 through 10) list by material the maximum suggested working pressure of various tubing sizes. Acceptable tubing diameters and wall thicknesses are those for which a rating is listed. Combinations, which do not have a pressure rating, are not recommended for use with instrument fittings.

Maximum Allowable Working Pressure Tables

Ratings in gray not suitable for gas service.

Table 5*

316 or 304 STAINLESS STEEL (Seamless)																
Tube O.D. Size	Wall Thickness															
	0.010	0.012	0.014	0.016	0.020	0.028	0.035	0.049	0.065	0.083	0.095	0.109	0.120	0.134	0.156	0.188
1/16	5600	6900	8200	9500	12100	16800										
1/8						8600	10900									
3/16						5500	7000	10300								
1/4						4000	5100	7500	10300							
5/16							4100	5900	8100							
3/8							3300	4800	6600							
1/2							2600	3700	5100	6700						
5/8								3000	4000	5200	6100					
3/4								2400	3300	4300	5000	5800				
7/8								2100	2800	3600	4200	4900				
1									2400	3200	3700	4200	4700			
1-1/4										2500	2900	3300	3700	4100	4900	
1-1/2											2400	2700	3000	3400	4000	4500
2												2000	2200	2500	2900	3200

Table 6*

316 or 304 STAINLESS STEEL (Welded)																
Tube O.D. Size	Wall Thickness															
	0.010	0.012	0.014	0.016	0.020	0.028	0.035	0.049	0.065	0.083	0.095	0.109	0.120	0.134	0.156	0.188
1/16	4800	5900	7000	8100	10300	14300										
1/8						7300	9300									
3/16						4700	6000	8700								
1/4						3400	4400	6400	8700							
5/16							3400	5000	6900							
3/8							2800	4100	5600							
1/2							2200	3200	4300	5700						
5/8								2500	3400	4500	5200					
3/4								2100	2800	3700	4200	4900				
7/8								1800	2400	3100	3600	4200				
1									2100	2700	3100	3600	4000			
1-1/4										2100	2400	2800	3100	3500	4200	
1-1/2											2000	2300	2600	2900	3400	4200
2												1700	1900	2100	2500	3000

***Notes for Tables 5 through 10:**

- All working pressures have been calculated using the maximum allowable stress levels in accordance with ASME/ANSI B31.3, Chemical Plant and Petroleum Refinery Piping or ASME/ANSI B31.1 Power Piping.
- All calculations are based on maximum outside diameter and minimum wall thickness.
- All working pressures are at ambient (72°F) temperature.

Maximum Allowable Working Pressure Tables are continued on the following page.

Maximum Allowable Working Pressure Tables (cont'd)

Ratings in gray not suitable for gas service.

Table 7*

Tube O.D. Size	CARBON STEEL (Seamless)											
	Wall Thickness											
	0.028	0.035	0.049	0.065	0.083	0.095	0.109	0.120	0.134	0.148	0.165	0.180
1/8	8100	10300										
3/16	5200	6700	9700									
1/4	3800	4900	7100	9700								
5/16		3800	5500	7700								
3/8		3100	4500	6200								
1/2		2300	3300	4500	6000							
5/8		1800	2600	3500	4600	5400						
3/4		2200	2900	3800	4400	5100						
7/8			1800	2500	3200	3700	4300					
1			1600	2100	2800	3200	3700	4100				
1-1/4				1700	2200	2500	2900	3200	3700	3800		
1-1/2					1800	2100	2400	2700	3000	3400	3800	4000
2						1600	1800	2000	2200	2500	2800	3000

Table 9*

Tube O.D. Size	ALUMINUM (Seamless)				
	Wall Thickness				
	0.035	0.049	0.065	0.083	0.095
1/8	8700				
3/16	5600	8100			
1/4	4100	5900			
5/16	3200	4600			
3/8	2600	3800			
1/2	1900	2800	3800		
5/8	1500	2200	2900		
3/4		1800	2400	3200	
7/8		1500	2100	2700	
1		1300	1800	2300	2700

Table 8*

Tube O.D. Size	COPPER (Seamless)									
	Wall Thickness									
	.010	.020	.028	.035	.049	.065	.083	.095	.109	.120
1/16	1700	3800	5400							
1/8			2800	3600						
3/16			1800	2300	3500					
1/4			1300	1700	2600	3500				
5/16				1300	2000	2800				
3/8				1100	1600	2300				
1/2					800	1200	1600	2200		
5/8						900	1300	1700	2000	
3/4							800	1000	1400	1900
7/8								600	900	1100
1									600	800
1-1/8										500
1-1/4										
1-1/2										

Table 10*

Tube O.D. Size	MONEL 400 (Seamless)									
	Wall Thickness									
	.010	.020	.028	.035	.049	.065	.083	.095	.109	.120
1/16	5500	11800	16300							
1/8			8100	10400						
3/16			5100	6600	9600					
1/4			3800	4800	7000	9600				
5/16				3800	5500	7500				
3/8				3100	4500	6100				
1/2					2300	3300	4500	5900		
5/8						2700	3700	4900	5600	
3/4							2300	3100	4000	4600
1								2300	2900	3400

***Notes for Tables 5 through 10:**

- All working pressures have been calculated using the maximum allowable stress levels in accordance with ASME/ANSI B31.3, Chemical Plant and Petroleum Refinery Piping or ASME/ANSI B31.1 Power Piping.
- All calculations are based on maximum outside diameter and minimum wall thickness.
- All working pressures are at ambient (72°F) temperature.

System Temperature

Operating temperature is another factor in determining the proper tubing material. Copper and aluminum tubing are suitable for low temperature media. Stainless steel and carbon steel tubing are suitable for higher temperature media. Special alloys such as Alloy 600 are recommended for extremely high temperatures (see Table 4). Table 11 lists derating factors which should be applied to the working pressures listed in Tables 5 through 10 for elevated temperature conditions. Simply locate the correct factor in Table 11 and multiply this by the appropriate value in Tables 5 through 10 for elevated temperature working pressure.

Table 11 – Temperature Derating Factors

Temperature		Copper	Aluminum	316 SS	304 SS	Steel	Monel 400
°F	(°C)						
100	(38)	1.00	1.00	1.00	1.00	1.00	1.00
200	(93)	.80	1.00	1.00	1.00	.96	.88
300	(149)	.78	.81	1.00	1.00	.90	.82
400	(204)	.50	.40	.97	.94	.86	.79
500	(260)			.90	.88	.82	.79
600	(316)			.85	.82	.77	.79
700	(371)			.82	.80	.73	.79
800	(427)			.80	.76	.59	.76
900	(486)			.78	.73		.43
1000	(538)			.77	.69		
1100	(593)			.62	.49		
1200	(649)			.37	.30		

EXAMPLE: 1/2" x .49 wall seamless 316 stainless steel tubing has a working pressure of 3700 psi @ room temperature. If the system were to operate @ 800°F (425°C), a factor of 80% or (.80) would apply (see Table 11 above) and the "at temperature" system pressure would be 3700 PSI x .80 = 2960 PSI.

Tubing Ordering Guidelines

Tubing for use with Parker instrument fittings must be carefully ordered to insure adequate quality for good performance. Each purchase order must specify the material nominal outside diameter, and wall thickness. Ordering to ASTM specifications insures that the tubing will be dimensionally, physically, and chemically within strict limits. Also, more stringent requirements may be added by the user. All tubing should be ordered free of scratches and suitable for bending.

A purchase order meeting the above criteria would read as follows:
 “1/2 x .049 316 stainless steel, seamless, or welded and redrawn per ASTM A-249. Fully annealed, 80 Rb or less. Must be suitable for bending; surface scratches, and imperfections (incomplete weld seams) are not permissible.”

Table 12 lists specific ordering information for each material.

Table 12

Material	Type	ASTM Tubing Spec.	Condition	Max. Recommended Hardness
Stainless Steel	304, 316, 316L	ASTM-A-269, A-249, A-213, A632	Fully Annealed	90 Rb
Copper	K or L	ASTM-B75 B68, B88 (K or L)*	Soft Annealed Temper 0	60 Max. Rockwell 15T
Carbon Steel	1010	SAE-J524b, J525b ASTM-A-179	Fully Annealed	72 Rb
Aluminum	Alloy 6061	ASTM B-210	T6 Temper	56 Rb
Monel® 400	400	ASTM B-165	Fully Annealed	75 Rb
Hastelloy® C-276	C-276	ASTM-B-622, B-626	Fully Annealed	90 Rb
Inconel® Alloy 600	600	ASTM B-167	Fully Annealed	90 Rb
Carpenter® 20	20CB-3	ASTM B-468	Fully Annealed	90 Rb
Titanium	Commercially Pure Grade 2	ASTM B-338	Fully Annealed	99 Rb 200 Brinell Typical

*B88 Copper Tube to be ordered non-engraved

Note: Hastelloy® is a registered trademark of Haynes International. Inconel®, and Monel® are registered trademarks of Special Metals Corporation. Carpenter® is a registered trademark of CRS Holdings Inc.

ASTM Tubing Specifications Outside Diameter/Wall Thickness

It is important to understand that both of the above can affect the ferrule(s) ability to seal on the tubing. We recommend ordering tubing manufactured to the plus (+) side of the outside diameter tolerance. Wall thickness variations can affect pressure ratings and flow characteristics.

The following tables should explain the allowable variations.

Table 13 Permissible Variations in Outside Diameter (1)

Table 14 Permissible Variations in Wall Thickness

Table 15 Permissible Variations in Wall Thickness for ASTM B68 and ASTM B75

ASTM Dimensionable Specifications for Tubing

Table 13 Permissible Variations in Outside Diameter*

Tube O.D. Inches	ASTM Specification									
	A213 A249	A269	A632	A179	B68 B75	B165 B167	B338	B468	B622	B626
1/16			+0.002			±0.002				
1/8			+0.003			±0.003				
3/16									N/A	
1/4			+0.004		±0.002	±0.004				
5/16	±0.004			±0.004			±0.004	±0.004		+0.004
3/8		±0.005								-0.005
1/2						±0.005			±0.005	
5/8										
3/4										
7/8					±0.0025	±0.0075				
1			N/A				±0.005		±0.0075	
1-1/4	±0.006			±0.006				±0.006		±0.006
1-1/2		±0.010			±0.003		±0.006			±0.008
2	±0.010			±0.010		±0.010	±0.007	±0.010	±0.010	±0.010

*Cold Drawn Tubing

Table 14 Permissible Variations in Wall Thickness

Tube O.D. Inches	ASTM Specification									
	A213	A249	A269	A632	A179	B165 B167	B338	B468	B622	B626
1/16	+20%	±10%	±15%	±10%	+20%	±15%	±10%	±15%	N/A	±12.5%
1/8										
3/16										
1/4										
5/16										
3/8										
1/2										
5/8										
3/4										
7/8										
1										
1-1/4										
1-1/2										
2										

Table 15 Permissible Variation in Wall Thickness (in Inches) for ASTM B68 and ASTM B75 Copper

Tube O.D. Inches	Wall Thickness						
	0.010	0.020	0.028	.035 .049	0.065	.083 .095 .109	0.120
1/16	±.002	±.003	±.003	±.003	N/A	N/A	N/A
1/8							
3/16	±.001	±.002	±.0025		±.0035	±.004	±.005
1/4							
5/16							
3/8							
1/2							
5/8							
3/4	±.0015	±.0025	±.003		±.0035	±.004	±.005
7/8							
1							
1-1/4	±.002	±.0025	±.003		±.0035	±.004	±.005
1-1/2							
2							

Tubing Preparation

Tube end preparation is essential in assuring leak-free systems. Some important points to consider are:

- Handling tubing
- Cutting tube end with either a tube cutter or hacksaw
- Deburring the tube end
- Cleaning the tube end

Handling Tubing

After tubing has been properly selected and ordered, careful handling is important.

From the receiving dock to point of installation, special attention is necessary to prevent scratching and burring the O.D. of the tubing. This is especially important for gas service. Low-density gases such as helium and argon cannot be sealed with damaged tubing.

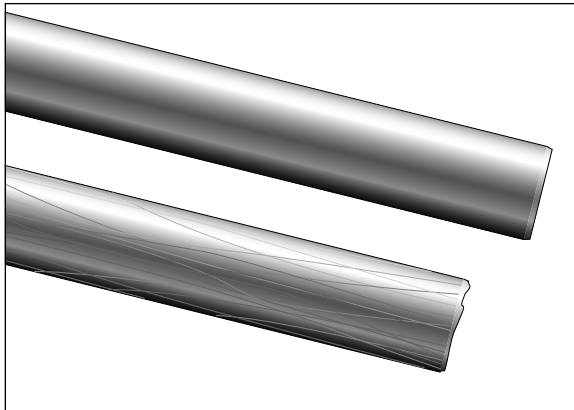

Figure 29

Make certain not to drag tubing across any surfaces such as truck beds, shelves, or storage racks, the floor and (or) ground of any plant/ construction site. This is important for tubing of all materials, particularly for copper and aluminum. Besides scratching, improper handling can create out-of-round tubing. Out-of-round tubing will not fit the I.D. of the ferrule(s) or the body bore properly and will cause leakage.

Cutting the Tube End

To insure a good joint, tube must be cut off square. This can be accomplished with either a tube cutter or hacksaw.

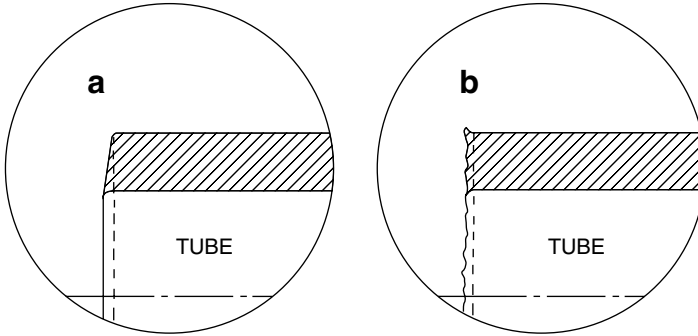

Figure 30 Enlarged section of tube showing differences in tubing cut with a tube cutter (a) and a hacksaw (b).

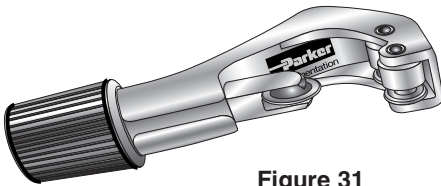

Figure 31

Tubing Cutters are more commonly utilized on softer tubing such as copper, aluminum or even “soft” steel tubing. If a tube cutter is utilized with stainless steel tubing, remember that a special cutting wheel, designed

for use with stainless steel tubing should be employed. The use of dull or improper cutting wheels can work harden the S.S. tubing near the cut area. This CAN adversely affect the fittings sealing ability.

Part Number: PT-C

Cutting with a Hacksaw – When using a hacksaw to cut off tubing, it is essential to use a guide to assure square cutoffs. We recommend our sawing vice (see Figure 32). Further, to minimize the residual burrs, a hacksaw blade of 32 teeth per inch minimum is suggested.

Sawing Vice Part Number: PT-V

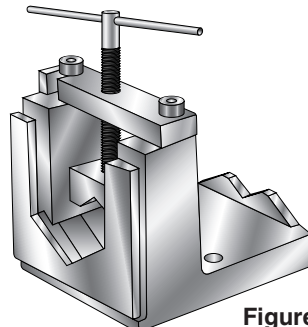

Figure 32

Deburring the Tube End

The burrs formed by either the tube cutter or hacksaw must be removed prior to assembly to prevent those burrs from eventually damaging the system. O.D. burrs can prevent tubing from seating properly in a fitting body. I.D. burrs can restrict flow, as well as possibly break loose and damage fine filtration elements.

Note: Do not over deburr the O.D. of tubing.

You may deburr the tubing with your choice of file(s) or utilize Parker's IN-EX De-burring tool. This tool can be used to deburr both the I.D. and O.D. of tubing sizes 1/8" thru 1-1/2".

IN-EX De-burring Tool Part Number: PT-D

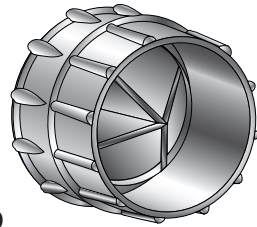

Figure 33

Cleaning the Tube End

After you deburr the tubing, it is essential to remove burrs from the tubing line. This can be accomplished by:

1. Flushing with solvent or low pressure compressed air.
2. Swab with lint-free cloth.

Again, this should prevent entrapping one of these small burrs down-stream where it might do some system damage.

Assembly

1. Parker instrument tube fittings are sold completely assembled and ready for immediate use. Simply insert the tube as illustrated in Figure 34 until it bottoms in the fitting body. (If the fitting is disassembled, note that the small tapered end of the ferrule(s) go into the fitting body.)
2. Tighten nut finger tight. Then tighten nut with wrench an additional 1/4 to 1-1/4 turns identified below and illustrated in Table 16. Hold fitting body with a second wrench to prevent body from turning. It is helpful to mark the nut to facilitate counting the number of turns.

For Sizes above 16 (1"), the Parker IPD Ferrule Presetting Tool must be used. Please see page 37 of this bulletin or Catalog 4290-INST for additional details.

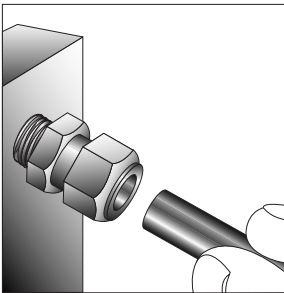

Figure 34

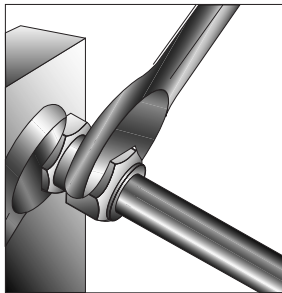

Figure 35

Description	Size	Wrench Tighten	Illustration
Tube Fittings	Inch Size 1 thru 3 (1/16" - 3/16") Metric Size 2 thru 4 (2-4mm)	3/4 turn from finger tight	
	Inch Size 4 thru 16 (1/4" - 1") Metric Size 6 thru 25 (6-25mm)	1-1/4 turns from finger tight	
Tube Plugs (FNZ/BLP)		1/4 turn from finger tight	
Port Connector (ZPC/PC)	Machined ferrule end only	1/4 turn from finger tight	

Table 16 Turns from Finger Tight

Remake

For maximum number of remakes, mark the fitting and nut before disassembly as indicated by "A" in Figure 36. Before retightening, make sure the assembly has been inserted into the fitting until the ferrule seats in the fitting. Retighten the nut by hand. Rotate the nut with a wrench to the original position as indicated by the previous marks lining up. (A noticeable increase in mechanical resistance will be felt indicating the ferrule is being re-sprung into sealing position.)

Only after several remakes will it become necessary to advance the nut slightly past the original position. This advance (indicated by B in Figure 36) need only be 10° -20° (less than 1/3 of a hex flat).

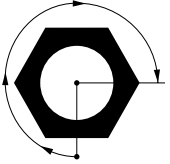
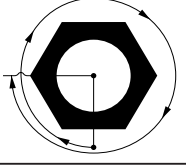
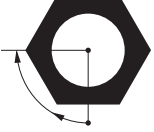
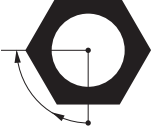
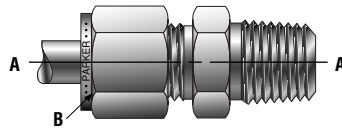

Figure 36

Parker CPI™/A-LOK® Fittings on Plastic Tubing

Parker CPI™/A-LOK® Instrument Fittings can be successfully used on any of the following plastic tubing: nylon, polyethylene, polypropylene, PTFE, or vinyl. Normal make-up instructions should be followed, (1-1/4" turns from finger tight) sizes 4 thru 16 (3/4 turn from finger tight for size 3" or below) and a properly-sized insert should be used when required. (Please refer to CPI™/A-LOK® Catalog 4230/4233 for insert details). The use of the insert is dependent upon tubing O.D. Tubing 1/2" O.D. and above requires an insert. Softness of the tubing is another guideline for the use of an insert. Tubing that is soft enough to be easily pinched closed with your fingers will require an insert no matter what the O.D. may be.

Gaugeability Instructions*

1. From “finger tight” position, wrench 1-1/4 turns for 1/4" to 1" size fittings (6mm to 25mm) (1/16", 1/8", 3/16", 2mm, 3mm, and 4mm size tube fittings only wrench 3/4 turn from finger tight position). Hold fitting body hex with second wrench to prevent body from turning as you tighten. It is a good idea to mark the nut (scribe or ink) to help you count the turns.
2. Now select the proper size inspection gauge and try to place it, as shown, between the nut and the body hex. If gauge does not fit at any point between them, you have correctly tightened the nut. If you can slip the gauge into the space, the fitting is not properly made up, and you must repeat the assembly procedure.

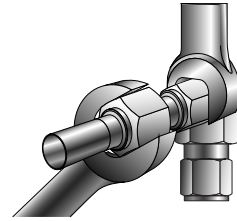

Figure 37

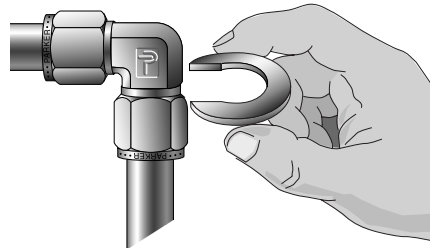

Figure 38

* For initial make up only.

Gap Gauge

This compact C-ring gauge is for inch and metric sizes. It effectively checks the gap dimensions for initial make-up. Can be combined on a key ring for easy handling.

Each gap gauge with the exception of the M10 is designed for an inch size with an equivalent metric size(s) as shown in Table 17.



Figure 39

Part Number	Tube Size	
	Inch	Metric
2 Gap Gauge	1/8	2-3
3 Gap Gauge	3/16	4
4 Gap Gauge	1/4	6
5 Gap Gauge	5/8	8
6 Gap Gauge	3/8	—
M10 Gap Gauge	—	10
8 Gap Gauge	1/2	12
10 Gap Gauge	5/8	14-15-16
12 Gap Gauge	3/4	18
14 Gap Gauge	7/8	20-22
16 Gap Gauge	1	25

Table 17

BSPB/SAE Straight Thread Fittings Installation Procedure

1. Lubricate O-ring with a lubricant that is compatible with the system.
2. Screw fitting into the straight thread port until the metal back-up washer contacts the face of the port.
3. Position the fitting by backing it out no more than one turn.
4. Hold the fitting in position and tighten the locknut until the washer contacts the face of the port. (See Table 18.)

Note: WLN lock nuts are ordered separately by size and part number. See Catalog 4230/4233.

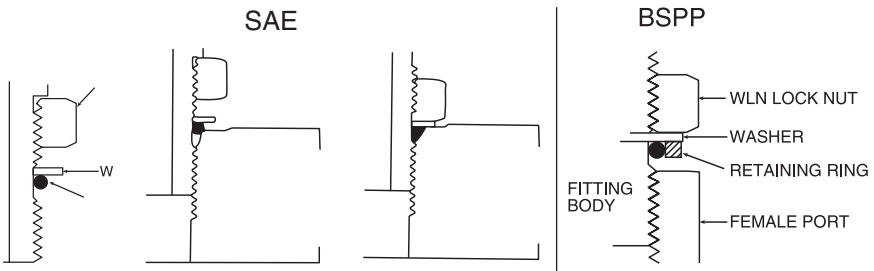

Figure 40

Figure 41

Size	Straight Port		Adjustable Port	
	Torque (in-lbs)	(F.F.F.T.)	Torque (in-lbs)	(F.F.F.T.)
4	245 ± 10	1.0 ± .25	200 ± 10	1.5 ± 25
6	630 ± 25	1.5 ± .25	400 ± 10	1.5 ± 25
8	1150 ± 50	1.5 ± .25	640 ± 10	1.5 ± 25
10	1550 ± 50	1.5 ± .25	1125 ± 50	1.5 ± 25
12	2050 ± 50	1.5 ± .25	1450 ± 50	1.5 ± 25
16	3000 ± 50	1.5 ± .25	2150 ± 50	1.5 ± 25
20	3400 ± 100	1.5 ± .25	2800 ± 100	2.0 ± 25
24	4500 ± 100	1.5 ± .25	3450 ± 100	2.0 ± 25

Table 18 Torque Chart

Notes:

- Restrain fitting body on adjustables if necessary in installation.
- Values in charts are for assemblies with O-ring lubricated.
- Use upper limits of torque ranges for stainless steel fittings.

Installation Face Seal O-Ring Fittings Installation Procedure

The O-ring requires a smooth, flat seating surface. This surface must be perpendicular to the axis of the threads.

1. Turn the O-ring seal fitting in the port until finger tight.
2. The “squeezing” effect on the O-ring can be felt during the last 1/4 turn.
3. Snug lightly with a wrench.

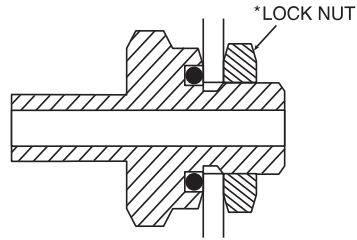

Figure 42

*Typical Application

The fitting can be adapted as a bulkhead fitting on thin wall tanks or vessels, eliminating welding, brazing or threading. Simply order the L5N locknut to take advantage of this option.

Port Size	Straight Thread Size	Straight Thread Machine Length	L5N Locknut Thickness	Maximum Tank Wall Thickness
2	5/16-24	.297	.219	.078 = 5/64
3	3/8-24	.297	.219	.078 = 5/64
4	7/16-20	.360	.250	.109 = 7/65
5	1/2-20	.360	.250	.109 = 7/64
6	9/16-18	.391	.265	.125 = 1/8
8	3/4-16	.438	.312	.125 = 1/8
10	7/8-14	.500	.360	.140 = 9/64
12	1-1/16-12	.594	.406	.188 = 3/16
14	1-13/16-12	.594	.406	.188 = 3/16
16	1-5/16-12	.594	.406	.188 = 3/16

Table 19

Notes:

- Standard O-rings are nitrile material. For other O-rings, state material after the part number.
- L5N locknuts are ordered separately by size and part number. See Catalog 4230/4233.

O-rings used with SAE/MS straight threads are nitrile. Other O-ring materials are available on request. Lubricate O-ring with a lubricant compatible with the system fluid, environment and O-ring material.

Parker IPD Ferrule Presetting Tool

Ferrule Presetting Components

Threads	Size	Part Numbers		Hy-Fer-Set Kit Components	
		Body Die	Nut Die	Item	Part No.
1/4"	4	4 Body Die	Size 4 Nut Die	Kit A Hydraulic Ram (size 4-16)	Hydraulic Ram
3/8"	6	6 Body Die	Size 6 Nut Die	Kit B Hydraulic Ram (size 20-32)	Hy-Fer-Set Body Assembly
1/2"	8	8 Body Die	Size 8 Nut Die	Hydraulic Hand Pump	Energac Pump P-392
5/8"	10	10 Body Die	Size 10 Nut Die	Hose Assembly	Hose Assembly w/guards
3/4"	12	12 Body Die	Size 12 Nut Die	Carrying Case	Carrying Case
7/8"	14	14 Body Die	Size 14 Nut Die		
1"	16	16 Body Die	Size 16 Nut Die		Size 16 Body Die Adapter
1-1/4"	20	20 Body Die	Size 20 Nut Die		
1-1/2"	24	24 Body Die	Size 24 Nut Die		
2"	32	32 Body Die	Size 32 Nut Die		

Table 20 Ferrule Presetting Components

Note: To preset 1" with "B" tool, a size 16 body die adapter must be used

IPD Ferrule Presetting Tool Assembly Instructions

Coupler body in hydraulic ram and pump, is a high pressure, screw together coupler. Thread coupler body onto nipple and each end of hose assembly. No tools required.

Presetting CPI™ /A-LOK® Tube Fitting Ferrules Sizes 1/4" Through 1"

1. Assemble CPI™/A-LOK® nut, CPI™/A-LOK® Ferrule(s) and body die onto tubing as shown in Figure 43. Be sure that the tapered end of the Ferrule(s) point toward the body die.
2. Insert "U-shaped" Nut Die into the back-up plate of the Hydraulic Ram as shown in Figure 44.
3. Insert Tube Assembly, Figure 43 into Nut Die as shown in Figure 45.

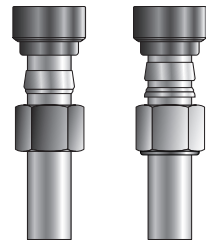

Figure 43

Instructions are continued on the following page.

4. Close the pressure relief valve on the side of the hand pump. Pump the hand pump until the ram reaches a positive stop. At this point an increase in resistance of the handle will be felt and the nut will bottom against the shoulder of the body die (Figure 46).
5. Release the hydraulic pressure by opening the relief valve on the side of the pump. The ram will automatically return to the original position.
6. The ferrule(s) are now preset on the tubing. Remove the preset assembly and pull the body die off the end of the tubing. (If the body die does not pull off by hand, clamp on the outside of the body die and move the tubing back and forth while pulling.) Do not clamp or pull on the preset ferrule(s) as this could damage a sealing surface.
7. Insert the preset assembly into a fitting body, and make sure the ferrule seats in the fitting. Tighten the nut on the fitting body until finger tight.
8. Tighten the nut with a wrench the additional amount shown in Table 21 for each connection size. (If an increase in torque is not felt early in wrench make-up the preset assembly was not properly seated.) If this happens, tighten the nut with a wrench until the torque increase is felt. Then, loosen nut to the finger tight position, tighten the nut the additional amount shown in Table 21.

Table 21

Size	Turns
4	1/2
6	1/2
8	1/2
10	1/2
12	1/2
14	1/2
16	1/2

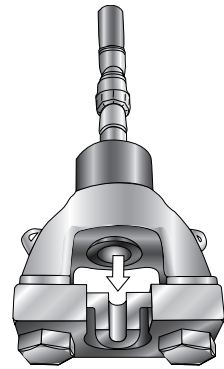

Figure 44

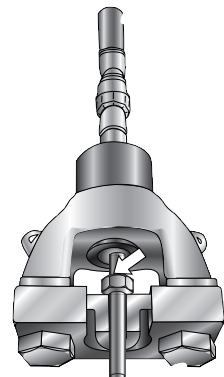

Figure 45

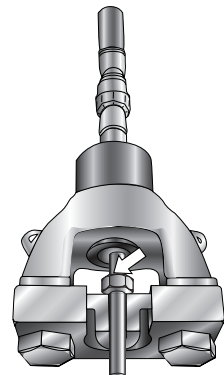

Figure 46

Pre-setting the CPI™ Tube Fitting Ferrules Size 1-1/4", 1-1/2", and 2"

1. Assemble CPI™ nut, CPI™ Ferrule and body die onto tubing as shown in Figure 47. Be sure that the tapered end of the ferrule point toward the body die.
2. Insert "U-shaped" Nut die into the Nut Die Adapter of the Hydraulic Ram as shown in Figure 48.

Note: For size 32 the nut die adapter is not needed and must be removed before inserting the nut die.

3. Insert Tube Assembly, Figure 47, into Nut Die as shown in Figure 49.
4. Close the pressure relief valve on the side of the hand pump. Pump the hand pump until the ram reaches a positive stop. At this point an increase in resistance of the handle will be felt and the nut will bottom against the shoulder of the body die Figure 50.
5. Release the hydraulic pressure by opening the relief valve on the side of the pump. The ram will automatically return to the original position.
6. The ferrule(s) are now preset on the tubing. Remove the preset assembly and pull the body die off the end of the tubing. (If the body die does not pull off by hand, clamp on the outside of the body die and move the tubing back and forth while pulling.) Do not clamp or pull on the preset ferrule(s) as this could damage a sealing surface.
7. Insert the preset assembly into a fitting body, and make sure the ferrule seats in the fitting. Tighten the nut on the fitting body until finger tight.

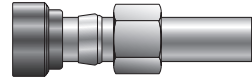

Figure 47

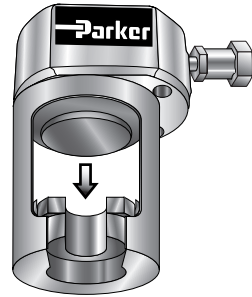

Figure 48

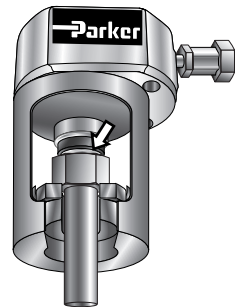

Figure 49

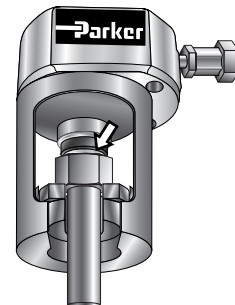

Figure 50

Instructions are continued on the following page.

- Tighten nut with a wrench the additional amount shown in Table 22 for each connection size. If an increase in torque is not felt early in wrench make up the preset assembly was not properly seated. If this happens, tighten the nut with a wrench until torque increase is felt. Then, loosen nut to the finger tight position, tighten nut the additional amount shown in Table 22.

Table 22

Size	Turns
20	5/8
24	5/8
32	3/4

Please Note: Pressure ratings for all Parker Hannifin instrumentation fittings are different because tubing thickness can vary widely. All instrumentation fittings are designed so the tubing is always weaker than the fitting. Thus the pressure rating of the fitting is contingent on the pressure rating of the associated tubing.

Minimum Tubing Lengths

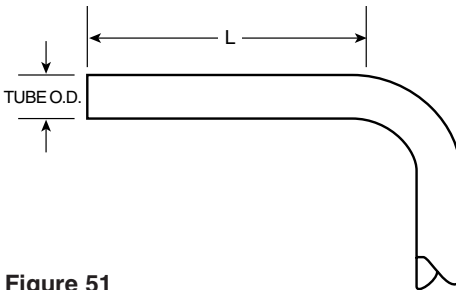

Figure 51

Note: You will need a minimum straight length of tubing ahead of any bend to fit into the presetting tool. See the “L” dimension in the chart for each tube O.D. size.

Table 23 “L” Chart

Tube O.D. (inches)	“L” (inches)
1/4	2
3/8	2-1/8
1/2	2-3/8
5/8	2-3/8
3/4	2-3/8
7/8	2-1/2
1	2-5/8
1-1/4	3
1-1/2	3-3/8
2	4-1/4

Note: Sizes 20, 24 and 32 moly-coated nuts do not need additional lubricant to facilitate installation of preset assemblies. All other size 20-24-32 nuts should have a system compatible lube (Loctite silver grade anti-seize or equivalent) applied to the fitting body, threads, and the inside back of nut. This will minimize effort required to assemble the fitting properly.

MPI™ Assembly

1. Parker MPI™ Fittings are sold completely assembled and ready for immediate use. Simply insert the tube as illustrated until it bottoms in the fitting body. (If the fitting is disassembled, note that the small tapered end of the ferrule(s) go into the fitting body.)
2. Turn the nut to the “finger-tight” position. Hold the fitting body with a second wrench to prevent the body from turning as you tighten the nut. For hand assembly, tighten the nut 1-1/2 turns. For 3/4" and 1" sizes, preset the nut and ferrules and then tighten the nut 1/2 turn only. See [page 42](#) for more information on preset connections. Parker recommends that you mark the nut (using a scribe or ink) to help you count the turns.

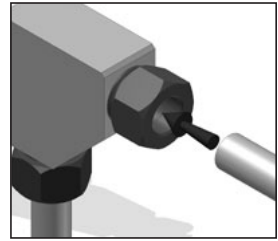

Figure 52

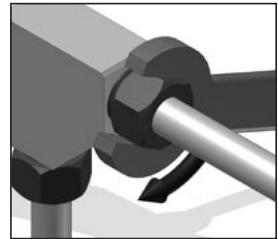

Figure 53

Gaugeability

Check the gap between the nut and the body hex with the end of the gauge by inserting the gauge (as shown) into the beveled gap between the nut and body hex. Gently turn the gauge (that is, it “twists out”). However, if the gauge slides into the beveled gap, (does not “twist out”) the fitting is not properly made up and you must check the entire assembly procedure.



Figure 54

Remake

For maximum number of remakes, mark the fitting and nut before disassembly. Before retightening, make sure the assembly has been inserted into the fitting until the ferrule seats in the fitting. Retighten the nut by hand. Rotate the nut with a wrench to the original position as indicated by the previous marks lining up. (A noticeable increase in mechanical resistance will be felt indicating the ferrule is being re-sprung into sealing position.)

MPI™ Hydraulic Preset Tools

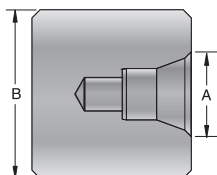

Figure 55 MPI™ Body Die

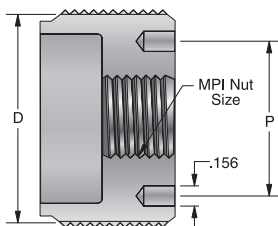

Figure 56 MPI™ Nut Die

Table 24 Body Dies and Nut Dies Used with the MPI™ Small Preset Assembly

MPI Small Preset Assembly		Inches					MPI™ Nut Size	Preset Pressure (PSIG)
Body Die Part No.	Nut Die Part No.	A	B	D	P			
4 MPI Body Die	4 MPI Nut Die	.50	1.25	1.62	1.20	4	3,200	
6 MPI Body Die	6 MPI Nut Die	.63	1.25	1.62	1.20	6	4,000	
8 MPI Body Die	8 MPI Nut Die	.82	1.25	1.62	1.20	8	6,800	
9 MPI Body Die	9 MPI Nut Die	.88	1.25	1.62	1.20	9	8,500	

Dimensions in inches are for reference only, subject to change.

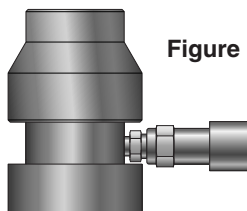

Figure 57
Parker Part No.
MPI SMALL Preset Assembly

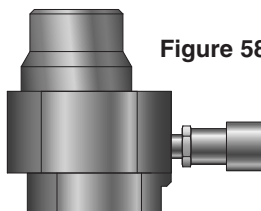

Figure 58
Parker Part No.
MPI LARGE Preset Assembly

Table 25 Body Dies and Nut Dies Used with the MPI™ Large Preset Assembly

MPI Large Preset Assembly		Inches					MPI™ Nut Size	Preset Pressure (PSIG)
Body Die Part No.	Nut Die Part No.	A	B	D	P			
*9 MPI Body Die	9 MPI Large Nut Die	.88	1.25	2.00	1.67	9	3,600	
12 MPI Body Die	12 MPI Nut Die	1.13	1.75	2.00	1.67	12	5,100	
16 MPI Body Die	16 MPI Nut Die	1.44	1.75	2.00	1.67	16	8,000	

* Requires a 9 MPI Body Die Adapter

Dimensions in inches are for reference only, subject to change.

Figure 59

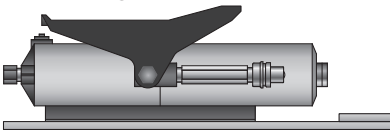

Parker Part No.
MPI AIR PUMP KIT

Figure 60

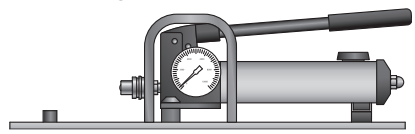

Parker Part No.
MPI HAND PUMP KIT

Installation

Note: One Pump Kit, Preset Assembly, Body Die and Nut Die are required for presetting. Pump Kits and Preset Assemblies can be interchanged but Body Dies and Nut Dies are for a specific Preset Assembly. Detailed operating instructions are included with each kit. Copies may also be obtained by contacting the Division.

Tubing Selection Guide

Although Parker's MPI™ Fittings are engineered and manufactured to consistently provide high levels of reliability, no system's integrity is complete without considering the critical link: tubing.

This section is intended to help you properly select and order quality tubing, both annealed and medium-pressure cold drawn – 1/8 hard (unannealed).

Parker believes that proper tubing selection and installation are key to building leak-free, reliable tubing systems.

Parker's MPI™ Fittings have been designed to operate on a wide variety of "medium pressure" applications (6,000 to 15,000 psi).

General Selection Criteria

The data tables in this section will help you select the tubing that best satisfies the needs of the application.

The most important consideration in the selection of suitable tubing for any application is the compatibility of the tubing materials with the media to be contained.

System Pressure

The system operating pressure is another important factor in determining the type, and more importantly, the size of tubing to be used. In general, high pressure installations require strong materials such as stainless steel. Tube fitting assemblies should never be pressurized beyond the recommended working pressure.

Temperature Derating Factors

Table 26 indicates derating factors for 316 stainless steel tubing and MPI™ fittings at elevated temperatures.

Table 26 Temperature Derating Factors

Temperature Derating Factors (316 Stainless Steel Tubing)										
°F	-425 to 100	200	300	400	500	600	700	800	900	1000
°C	-254 to 38	93	149	204	260	316	371	427	482	538
1/8 Hard*	1.000	1.000	1.000	0.960	0.885	0.835	0.795	0.770	0.750	0.740
Annealed**	1.000	1.000	1.000	0.965	0.895	0.850	0.815	0.795	0.775	0.765

* Use with 1/8 Hard 316 tubing shown in [Table 27](#) and [Table 28](#) on pages 46 and 47.

** Use with Annealed 316 tubing shown in [Table 29](#) on page 47.

The rating at temperature is the room temperature (RT) pressure rating listed in the catalog multiplied by the Derating Factor at temperature.

Example: 1/4" MPI™ fittings and tubing @ 800°F

Room Temperature
Working Pressure
= 15,000 psi
(as shown in [Table 27](#))

800°F Temperature
Derating Factor
= .770 (1/8 Hard tube)
(as shown above)

<p>800°F Working Pressure = 15,000 x .770 = 11,550 psi</p>	
---	--

Maximum Allowable Working Pressure Tables

Tables 27, 28 and 29 list the maximum suggested working pressure of various tubing sizes, according to material. Acceptable tubing diameters and wall thicknesses are those for which a rating is listed. Combinations which do not have a pressure rating are not recommended for use with MPI™ Fittings.

MPI™ Tubing

MPI™ tubing is marked “MPI” and is designed to provide optimum performance for MPI™ fittings. MPI™ tubing is nominal OD ± .003” 316 seamless stainless steel, cold drawn – 1/8 hard (unannealed) tubing. Tensile strength is approximately 40% higher than annealed tubing.

Table 27 – 316 Stainless Steel (Seamless/Unannealed – 1/8 Hard)

Tube Size (in.)	Nominal OD (in.)	Nominal ID (in.)	Working Pressure (psi)	MPI™ Tube Part No.
1/4	.250	.125	15,000	4-240 MPITube-SS-15K
3/8	.375	.219	15,000	6-240 MPITube-SS-15K
9/16	.562	.344	15,000	9-240 MPITube-SS-15K
3/4	.750	.469	15,000	12-240 MPITube-SS-15K
1	1.000	.656	12,500	16-240 MPITube-SS-12K

Note: Working pressures calculated using an allowable stress of 35,000 psi for 1/8 hard 316 stainless steel tubing with a minimum tensile strength of 105,000 psi.

Note: Sizes 3/4" & 1" require hydraulic presetting when used with MPI™ fittings.

***Consult factory for pressure tables regarding other materials.**

Dimensions in inches are for reference only, subject to change.

Cone & Thread Tubing

Cone & Thread (C&T) tubing is available as 1/8 hard 316 seamless stainless steel tubing and is designed to work with existing C&T fittings. C&T tubing has an undersized OD by as much as .010" to better facilitate the coning and threading operations required for use with C&T fittings. MPI™ fittings work effectively with C&T tubing as listed below but **require hydraulic presetting** for optimum performance.

Table 28 – 316 Stainless Steel (Undersized OD, Seamless/Unannealed – 1/8 Hard)

Tube Size (in.)	Maximum OD (in.)	Nominal ID (in.)	Working Pressure (psi)	Tube Size (in.)	Maximum OD (in.)	Nominal ID (in.)	Working Pressure (psi)
1/4	.250	.109	12,500	9/16	.562	.359	10,000
3/8	.375	.203	12,500	3/4	.750	.516	10,000
9/16	.562	.312	12,500	1	1.000	.688	10,000

Dimensions in inches are for reference only, subject to change.

Instrumentation Grade Heavy Wall Tubing

Table 29 – 316 Stainless Steel (Seamless/Annealed)

Tube Size (in.)	Tube Wall Thickness (in.)								
	.065	.083	.095	.109	.120	.134	.156	.188	.220
	Working Pressure (psi)								
1/4	10,300	13,300							
3/8	6,600	8,600	10,000	11,700					
1/2		6,700	7,800	9,100	10,000	11,400			
3/4				5,800	6,400	7,300	8,600	10,600	
1					4,700	5,300	6,200	7,700	9,200

Note: Working pressures calculated using an allowable stress of 20,000 psi for annealed 316 stainless steel tubing with a nominal O.D. tolerance of $\pm .005$ ".

Dimensions in inches are for reference only, subject to change.

Dielectric Fittings

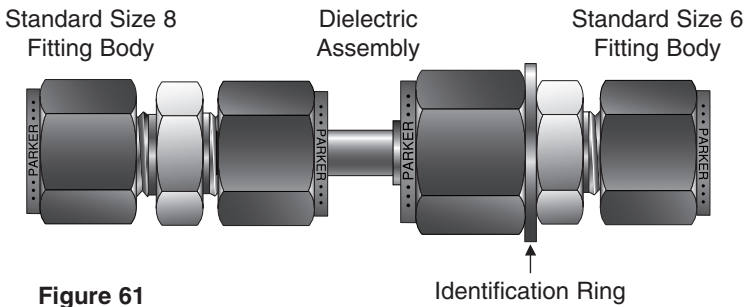

Figure 61

1. Place Identification Ring over size 8 fitting body.
2. Insert size 8 (dielectric end) into standard fitting body and tighten nut until finger tight. Tighten with wrench until nut contacts identification ring.
3. Insert tube end with pre-set nut and ferrule(s) into fitting body and tighten until finger tight. Tighten with wrench 1/4 turn from finger tight.

High Integrity Coupling Assembly

UltraSeal™

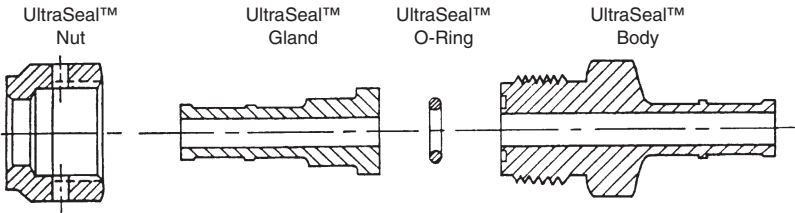

Figure 62

A positive seal is achieved by advancing the nut no less than 1/4 turn from finger tight position. When a sharp rise in torque is felt, the sealing faces have met and the O-ring seal is compressed into its groove.

UltraSeal™ is capable of repeated remakes; advance the nut to a finger tight position and wrench until a sharp rise in torque is felt.

VacuSeal™



Figure 63

Remove the protector cap from the toroid. Place the gasket into the female nut where applicable. Assemble components and snug finger tight. Holding a backup wrench stationary, tighten the female nut 1/8 turn past finger tight for 316-SS or nickel gaskets. Upon remake a new gasket should be installed each time.

Installation of Weld Fittings

Automatic Buttweld

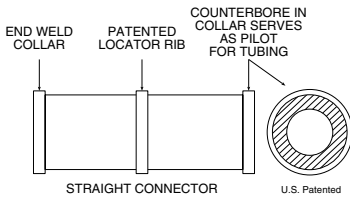

Figure 64 The Automatic Buttweld fitting has a locator rib positioned a fixed distance from the end weld collar.

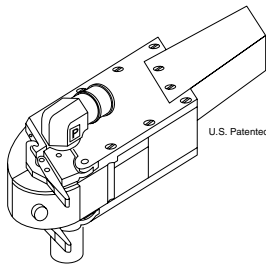

Figure 65 The orbiting electrode is precisely positioned over the end collar by engaging the locator rib within the weld head.

Note: The weld head shown is for illustration only.

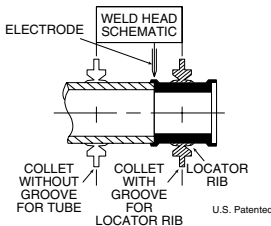

Figure 66 The orbital welder electrode is shielded within the stationary head and rotates 360° to produce uniform, accurate welds.

Mini Buttweld Tube Fittings

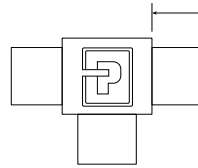

Figure 67 The Mini-Buttweld tube fitting has a controlled distance from the fitting body shoulder to the end of the tube stub.

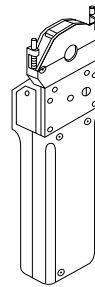

Figure 68 – The orbiting electrode is positioned over the fitting end by batting against the body.

Note: The weld head shown is for illustration only.

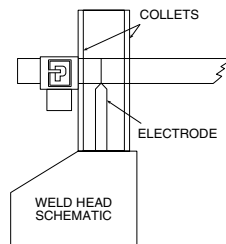

Figure 69 – The orbital welded electrode is shielded within the mini-weld head and rotates 360° to produce uniform, accurate, 100% penetration welds.

Purpose

Parker Orbital Tube Weld fittings are designed for applications requiring the reliability of a welded tubing system. They were developed specifically for installation using automatic, orbital TIG (Tungsten/Inert Gas) welding equipment.

Parker Weld fittings offer the easiest, fastest and most reliable way to fabricate welded systems.

Parker MiniButtweld Tube Fittings are available in VIM/VAR stainless steel in tees, 90° elbows, reducers and mini glands.

Orbital Tube Weld Fittings are available in AOD/VAR and VIM/VAR stainless steel in straight unions, tees and 90° elbows. Orbital Buttweld ends are also available with male pipe and compression tube connections.

For high integrity mechanical connections for positive pressure and vacuum applications in ultra-pure systems, Buttweld fittings may be specified with an UltraSeal or VacuSeal Coupling.

Pressure

Buttweld pressure ratings will be governed by the tubing wall thickness selected for a particular application.

Buttweld working pressures are rated at room temperature based on a 4-to-1 design factor. Pressure ratings are calculated in accordance with ANSI Power Piping Code B31.1.

Interior (I.D.) Surface Finishes

Orbital Tube Weld and MiniButtweld Tube Fittings can be supplied with extremely smooth internal surface finishes to meet requirements of high purity tubing systems. Electropolished internal surfaces can also be provided. Consult your local Parker distributor or factory for more details.

Automatic Buttweld Principles of Operation

Parker's patented Automatic Buttweld tube fittings are designed specifically for installation by means of automatic, orbital TIG (Tungsten/Inert Gas) welding machines. Any one of several makes may be used; their names are available from Parker upon request.

In an orbital welder, the electrode is contained and shielded within the head (see [Figure 65 on page 50](#)). The head itself does not rotate; rather, the electrode rotates 360° within the head.

An orbital-type welder utilizes high-frequency current pulses, producing low-frequency arc pulses. These yield considerable arc penetration into the metal at low current values. As a result, arc-pressure variations are kept low and the resulting agitation of the weld puddle eliminates porosity and refines the grain structure at the weld area.

To Operate a TIG Welding Machine

1. Place the Automatic Buttweld fitting into the weld head, placing the locator rib in the corresponding locator groove. For MiniButtweld, place the fitting into the mini-weld head and position the fitting body shoulder against the tube clamp assembly.
2. Bottom the tubing (square cut, deburred) in the fitting end collar and close the second collet, which locks the tubing to the weld head. Engage the second collet.
3. Close the weld head. Press the “Start” button.

Depending on the size and wall-thickness of the tubing, the welding machine parameters can be programmed to make one or more 360° passes. Once programmed, the machine will repeat the operation precisely, within very close tolerances and in areas too tight for manual welding.

Automatic Centering of Electrode

Each Automatic Buttweld fitting has an external locator rib (patented) situated a fixed distance from the end welding collar (see [Figure 64 on page 50](#)). When the welder-head clamping collet is applied, the rib fits snugly within a corresponding annular groove in the collet.

As the electrode orbits, the collet follows the rib, maintaining precise positioning of the electrode, over the end collar (see [Figure 66 on page 50](#)). Thus, electrode and welding positioning are always accurately aligned.

End Weld Collar

On the O.D. of each Automatic Buttweld fitting end, there is an end collar. During welding, the electrode tip is positioned directly over this end collar. As the electrode orbits, a uniform bead on the buttseam is achieved.

Like the locator rib, the end collar is an exclusive Parker feature.

Piloted Mating of Tube to Fitting

The end collar of the Automatic Buttweld fitting is counter bored. This serves as a pilot for the tube end, guiding it accurately into the fitting end.

Compensation for Tube-Thickness Variations

The outside diameter of the end collar is designed to compensate for normal variations in the nominal O.D. of instrumentation tubing.

In addition, each fitting is machined for the specific wall thickness being specified.

These two features allow for the fitting bore and tube I.D. to be carefully matched. Thus, an ABW connection will allow for full flow, with no protrusions extending into the flow path. This will reduce a major cause of turbulence.

Socket Weld Fittings

General

The weld used in joining a tube to a socket weld tube fitting is like any other type of "tee" weld. The root (i.e., the point of intersection of the outside of the tube and annular end area of the fitting) must be included in the weld zone.

Careful welding procedures are normally followed to assure that this root area is included in the weld. If penetration is not achieved, the joint will have two built-in stress risers which may greatly reduce the strength of the weld. Upon application of an extreme load, these stress risers could result in cracks which could propagate out through the weld or tube depending upon the direction of the greatest load.

Often to achieve full root penetration in TIG welding of stainless steels, a fusion pass will be made first, followed by a final pass utilizing a filler rod to achieve the desired fillet size.

Assembly

The codes applicable to the welding of socket weld fittings require that the tube be inserted into the socket until bottomed against the stop. The tube is then to be backed out approximately 1/16" and then welded.

If the tube is not backed out, but welded when against a flat bottom stop, the contraction of the weld fillet and fitting socket can combine to produce a static stress on the weld. During thermal transients, the fitting and the portion of the tube within the fitting may experience a differential rate of heating or cooling, again adding to the stress level in the weld.

Tacking

If the weld joint is to be “tacked” before welding, it is recommended that the “tack” weld build-up be held to a minimum.

Excessive build-up on the “tack” may cause an interrupted final bead and a stress riser or lack of complete fusion.

Backing Gas

Backing gas is an inert gas used to flood the interior of the fittings and tube system during welding. It serves the same purpose internally as the shielding gas used in TIG or MIG welding. By reducing the interior oxygen level to as low as practicable, it also serves to control the combustion of contaminants that could affect weld quality.

When a backing gas is not used and nearly 100% weld penetration is achieved, blisters will tend to form on the internal tube wall. This will result in scale which may later break loose. Therefore, in 0.050 wall or thinner tube or where the wall thickness is such that the selected weld process may burn through, the use of a backing gas is mandatory.

In most cases the backing gas will be argon or helium connected to the system through a control regulator. Flow rates, while small, should be high enough to purge the system. Welds should be made in downstream sequence from the gas connection.

Note that the entire system should be purged to insure that there are no openings that will allow air to be drawn into the system.

The use of backing gas, while often not mandatory, will give a better weld joint. This is because the effects of contaminate combustion by-products are eliminated and because the welds are made and cooled under a shielded atmosphere, thus eliminating internal scaling or blistering.

Welding Methods

300 Series Stainless Steels

May be welded by the TIG, MIG, or stick arc-weld process.

TIG welding is recommended as being best for welding Weld-lok® systems because it allows better operator control of heat penetration and filler material deposition.

Stick arc welding is not recommended in many cases because of the likelihood of excessive burn-through and improper root penetration. In all cases where stick welding is used, it is recommended that backing gas be used.

MIG welding gives the same characteristics as stick electrode welding with faster deposition of the filler material.

As this process runs “hotter” than the stick process, the use of a backing gas is mandatory. It should be noted that in welding the relatively small fitting sizes found in the Weld-lok® line, filler deposition rate economies are not a factor and therefore the MIG method is not commonly applied.

C1018 Steel Fittings

May be welded by the TIG, MIG, stick and oxyacetylene methods. As scale formation remains a problem, the use of a backing gas is still recommended.

Carbide Precipitation

When unstabilized stainless steels are heated to 800° – 1,500°F during welding, the chromium in the steel combines with the carbon to form chrome carbides which tend to form along the grain boundaries of the metal (carbide precipitation). This lowers the dissolved chromium content in these areas and thus lowers their corrosion resistance, making them vulnerable to intergranular corrosion. Carbide precipitation is reduced by holding the carbon content of the material to a very low value. This limits the amount of carbon available to combine with the chromium. The “L” series (extra low carbon) stainless steels are often used for this purpose, but their use reduces system design stress by approximately 15%. Parker Weld-lok® fittings are made from a select 316 series with carbon content in the low range of 0.04 to 0.07 percent. This results in a welded fitting with good corrosion resistance and a high strength factor.

All Parker Weld-lok® fittings in stainless steel are supplied in the solution-treated condition, capable of passing ASTM-A-262 Tests for Detecting Susceptibility to Intergranular Corrosion.

ARC Polarity

When welding Weld-lok® fittings, best results will be obtained by the following arc polarities:

- TIG – Direct Current, straight polarity
- MIG – Direct Current, reverse polarity
- STICK – Polarity dependent on rod used

For further information on Parker’s Welded Fittings refer to Parker’s Welded Fittings Catalog 4280.

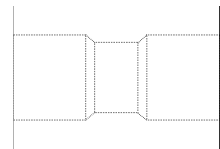

Figure 70 Parker Weld-lok® Union

Analytical Tube Fittings

Parker Hannifin's Instrumentation Connectors Division offers a full line of analytical tube fittings. These fittings range from elbows, tees, and male connectors to low dead volume unions and column end fittings. Parker incorporates various features in the column end fittings to effectively address various industry concerns.

- Peak symmetry for critical analysis
- Internal volume reduction

As the observed media/substance migrates through the HPLC column, a "peak" or "band" is created that denotes the level of concentration.

It is critical to maintain peak symmetry in order to get an accurate reading when processing the observed media/substance. Parker Hannifin, in the development of a line of column-end fittings, has incorporated some key features that help to maintain this "peak symmetry" in HPLC columns.

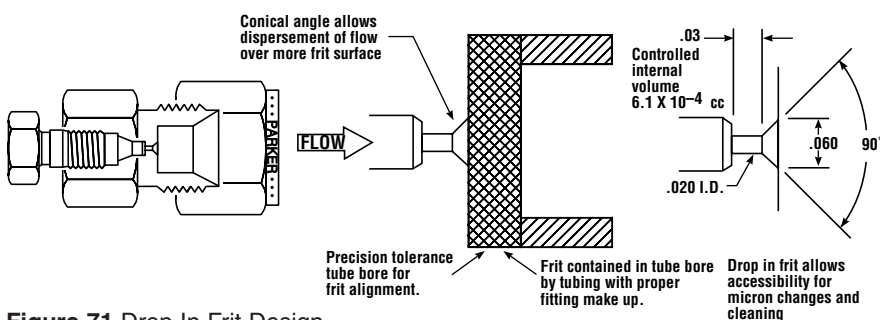

Figure 71 Drop In Frit Design

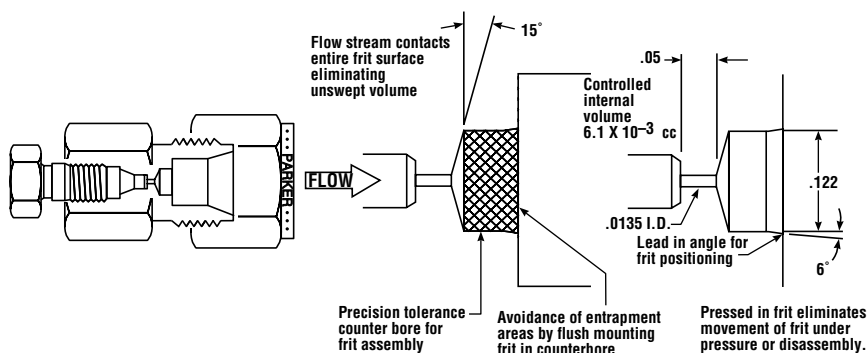

Figure 72 Press In Frit Design

Under most circumstances in liquid chromatography (LC), the flow through the tube is laminar, the so-called Poiseuille flow, and in this situation the velocity at all points is parallel to the tube axis.

Due to the importance of maintaining smooth laminar flow after injection of the sample into the HPLC column, Parker incorporated a small conical angle on the fitting body internals. This conical angle helps to equally disperse the sample into the column tube. One of the key requirements of an effective column-end fitting is not to delay or disturb the flow of the sample through the instrument (HPLC column).

A second area to address is the minimizing of tube fitting internal “cavities”. A cavity is a short section of the flow path where the flow-channel diameter increases. It can occur where tubes are connected to each other (low dead volume connector) or to injectors, columns (column-end fittings), and detectors. Large cavities can seriously degrade the resolution of any chromatogram, but they can be easily avoided through awareness of the geometric design details of the fittings and connecting parts manufactured by various companies.”

Parker Hannifin has incorporated those critical features in both a low dead volume union connector and the column-end fitting bodies. First, the utilization of inverted 1/16" connections to greatly reduce internal volume or cavities. To eliminate any confusion or occurrence of incorrect effective tube make-up, the port depths (body bore dimensions) are identical by size throughout the entire Parker Hannifin instrumentation line. Second, Parker closely monitors the dimensions of the small through-hole utilized in these low dead volume connectors.

Heat Code Traceability

Parker Hannifin's Instrumentation Products Divisions offer the following stainless steel high quality fittings and document Heat Code Traceability (HCT).

- CPI™ Tube Fittings
- A-LOK® Tube Fittings
- Instrumentation Pipe Fittings
- Orbital Tube Weld Fittings
- MiniButtweld Fittings
- VacuSeal Couplings
- UltraSeal Couplings
- Needle Valves
- Ball Valves
- Check Valves
- Filters

HCT refers to the fact that a particular part can be traced back to the original mill heat of metal from which it was made. Beginning with the original melt, a package of documents is created which completely describes the metal in physical and chemical terms. The end result is that a number which is permanently stamped to the part, refers back to the document package.

The HCT number is stamped on the material (bar stock or forging) prior to manufacturing. The concept is useful because it provides a method for complete material accountability for the manufacturer and end customer.

For instance, interpretations of applicable specifications governing the use of materials in nuclear power plants lean toward the idea that HCT materials are not mandatory on 3/4" and smaller pipe (1" and smaller O.D. tubing) lines. However, heat code traceability for larger material sizes is mandatory and many designers insist that the protection offered by heat code traceability may be made part of small line installations as well, especially what is known as Class 1 or critical applications. Only Parker tube fittings offer the nuclear designer the capability to specify heat code traceability for his pressure retaining fitting bodies.

The material used in Parker Hannifin instrumentation fitting components is 316 or 316L (welded products) stainless steel as specified and referenced in Section III of the ASME Boiler and Pressure Vessel code.

The American Society of Mechanical Engineers (ASME) Boiler and Pressure Vessel code, Section III, latest issue, entitles Rules for Construction of Nuclear Power Plant Components, is the principal document covering this type of fitting in the nuclear field. ANSI Standard B 31.1.0, Power Piping, and ANSI Standard B 31.7, Nuclear Power Piping are also important documents in the field.

In addition to the documentation of chemical and physical properties, great care is taken throughout the manufacture of Parker's tube fittings to ensure that potential stress corrosion will not be a problem in normal usage of the parts. Manufacturing processes avoid exposure of the parts to mercury or halogens, and control of thermal treatment avoids the condition known as continuous grain boundary carbide precipitation.

The entire product line of stainless steel instrumentation fittings is manufactured to meet or exceed all applicable specifications to assure the designer that he is working with a quality product. This also assures the engineer, the contractor, and the customer that they are working with a high quality product that is in full compliance with all applicable specifications.

These specifications ensure high quality instrumentation fittings for use in fossil fuel power plants, chemical refineries, general instrumentation and processing plants. Requirements are now emerging in the semiconductor and pharmaceutical industries.

Not only are the materials continuously monitored, but Parker adheres to a formal, documented Quality Assurance Program that controls manufacture, marking, testing and examination procedures, cleaning and packaging.

Although not all customer orders require the high degree of quality assurance imposed by Parker, it is the policy of the company to manufacture products to meet all existing specifications, as well as anticipated future requirements in the area of Heat Code Traceability.

HCT offers these advantages:

- Raw materials for manufacture must meet code requirements. This can be verified through documentation so that the customer is certain that what is ordered is received.
- HCT provides a record of chemical analysis with the raw material. Thus, in areas requiring welding, the correct welding technique is applied.

HCT relieves the user of Parker instrumentation tube fittings of any doubts. It acts as an assurance for today and for tomorrow.

Parker Suparcase® – Ferrule Hardening

Instrumentation tube fittings were on the market for only a short time when manufacturers realized that a pure compression 316 stainless steel fitting, single or double ferrule, while working well with fluids would not effectively seal gases. Nor would stainless steel compression ferrules hold to the working pressure of the many tube wall thicknesses being specified. Also, compression ferrules would not effectively seal gases on stainless steel tubing with surface imperfections. It became evident that it would be necessary to harden the surface of the ferrule to improve service performance. All fitting manufacturers began to harden the leading edge of the ferrules to solve this problem.

Parker's Instrumentation Products Division was not alone in recognizing the application problems associated with pure compression stainless steel fittings. But, as often happens with engineering trade-offs, chemical hardening, while a solution to the problem at hand, affected and changed the chemistry of the 316 stainless material.

Chemical hardening of the ferrule reduced its resistance to corrosion.

The race was on to find a new way to maintain the benefits of chemical hardening without changing the base chemistry of the 316 stainless material. Parker has taken the lead in the development of the chemical hardening process ideal for ferrules designed to grip and seal stainless steel tubing. The process, a technological breakthrough, is called *Suparcase®*.

Parker Suparcase® is a proprietary chemical process for the treatment of ASTM 316 stainless steel ferrules that imparts a unique set of physical characteristics that greatly enhances the corrosion resistance and hardness of ASTM 316 stainless steel. The *Parker Suparcase®* ferrules offer several important advantages over untreated ASTM 316 stainless steel.

The first important advantage lies in performance in corrosive environments. When compared to untreated ASTM 316 stainless steel, *Suparcase®* offers at least equivalent or better performance in the following corrosive environments:

- 50% sulfuric acid solution at 25°C
- 50% nitric acid solution at 25°C
- 30% acetic acid solution at 25°C
- 5% sodium hypochlorite at 25°C
- Type II simulated black liquor at 25°C
(TAPPI TIS 0402-09)

Standard stress corrosion cracking tests have been performed on Suparcased ASTM 316 stainless steel, and untreated ASTM 316 stainless steel. The tests were conducted on U-bend specimens and on standard tensile specimens in chloride, hydroxide, and sulfide solutions. These tests have shown that the *Suparcase®* is at least equivalent or better in performance in resistance to stress corrosion cracking as compared to untreated ASTM 316 stainless steel.

Also, the *Suparcase®* ferrule has a surface hardness exceeding that of untreated ASTM 316 stainless steel enabling the *Suparcase®* ferrule to grip and seal ASTM 316 stainless steel tubing.

Over the past several years, IPD has made dramatic product quality improvements. Improvements have been made in forging quality, body seats and tube bore surfaces, pipe threads, nut quality, I.D. surface finishes, overall improved tolerances and now *Suparcase®*, the ultimate product advantage.

The *Parker Suparcase®* ferrule is a new breakthrough as a result of technology transfer from extensive research into super-corrosion resistant austenitic stainless steel by Parker's Research and Development Group. The *Suparcase®* ferrule has been developed to greatly enhance the corrosion resistance and hardness at ASTM type 316 stainless steel. Due to the *Suparcase®* ferrule's unique set of physical characteristics, it's ideal for instrumentation fitting ferrules which must seal and grip on commercial stainless steel tubing.

The *Parker Suparcase®* ferrule has the following features, advantages and benefits to the user:

1. Superior or equal to ASTM type 316 stainless steel in a broad range of corrosive applications.
2. Not affected by the standard working temperatures of ASTM type 316 stainless steel.
3. Superior resistance to pitting compared to ASTM 316.
4. Superior to ASTM 316 in stress corrosion tests.
5. A high surface hardness that prevents galling and increases remakes.
6. Proven in field applications throughout the world.

Table 30 Typical Sample of Corrosion Resistance

Corrosion Environment	Suparcase® Ferrule Compared to Untreated ASTM 316
Acetic Acid	Superior
Boiling Nitric Acid	Equivalent
Hydrochloric Acid	Equivalent
ASTM Salt Spray Test #B117	Equivalent
Sulfuric Acid	Superior
SO ₂ Atmosphere	Equivalent
34% MgCL ₂ Stress Corrosion Test	Superior

Thread Identification

We are frequently asked to explain the differences in various types of threads, as piping specifications and (or) equipment are designed with the following threaded connections:

1. NPT
2. BSPT
3. BSPP
4. Screw Thread
5. SAE Straight Thread
6. Metric Thread

NPT Thread

NPT, National Pipe Thread or pipe taper is the most commonly used pipe thread in the United States and Canada.

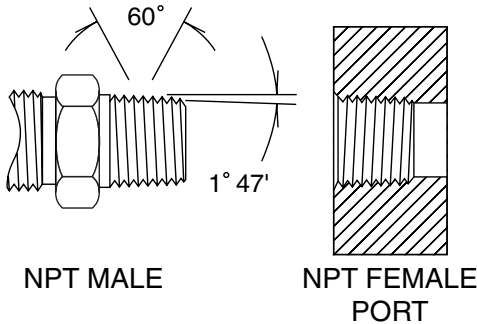

Figure 73 NPT (National Pipe Taper)

Characteristics of NPT

1. Thread pitch measured in inches
2. Root and crest truncation are flat
3. 60° Thread Angle
4. Taper Angle 1° 47'

Parker's Instrumentation Products Division machines this thread on all CPI™, A-LOK® as well as on pipe & pipe adapter fittings where NPT is designated. All male threads are rolled for strength and durability. Parker IPD's NPT threads meet the standards set forth by ANSI B 1.20.1

BSPT – British Standard Taper

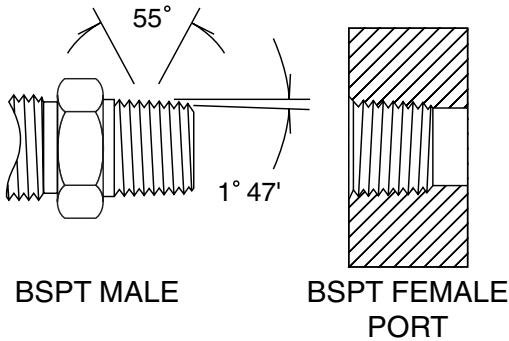

Figure 74 BSPT

Characteristics of BSPT

1. Taper Angle $1^{\circ} 47'$
2. 55° thread angle
3. Pitch can be measured in millimeters or inches
4. Thread truncation is round

BSPT threads are different from and will not substitute for NPT threads.

The following standards are equivalent to BSPT

- ISO 7/1 (International Standards Organization)
- DIN 2999 (Deutsche Industrial Norme)
- JIS B0203 (Japanese Industrial Standard)
- BS 21 British Standard

BSPP – British Standard Parallel Pipe

Form A

A self centering taper is used at the hex which centers a “Bonded” washer (usually metal and elastomer) to seal to the surface surrounding the female thread.

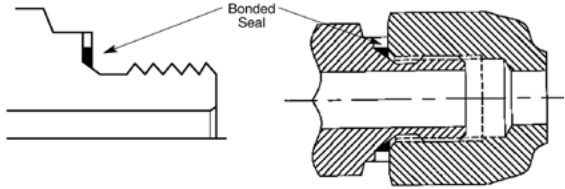

Form B

A metal gasket (usually copper) performs the seal between the face of the body and the face of the female threaded component. For Form “B” replace “R” in P/N with “BR”.

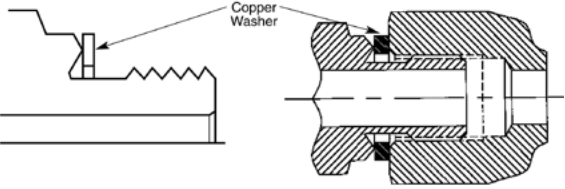

Figure 75 BSPP

Characteristics of BSPP

1. 55° thread angle
2. Thread pitch measured in inches
3. Thread diameter measured in inches
4. Root/Crest Truncation round

A parallel thread form uses the threads for holding power only and seals by means of an O-ring and retainer ring.

The following standards are equivalent to BSPP

- a. ISO 228/1 (International Standards Organization)
- b. DIN 3852 Part 2 and Parallel threads (Deutsche Industrial Norme)
- c. JIS B0202 (Japanese Industrial Standard)
- d. BS 2779 (British Standard)

Unified Screw Threads

These are very common threads utilized on valves and fitting stems, nut and fitting end threads. They are straight, not tapered threads used for holding power.

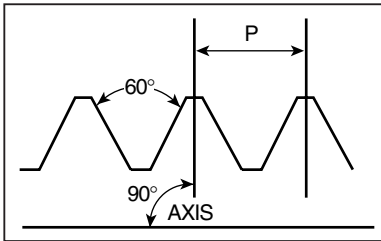

Figure 76

Screw threads are denoted by the following:

For example:

5/16	—	20
Thread		Number of
Diameter		Threads per inch

In general – screw threads can be further classified into various types of pitch (UNF) Unified Fine Pitch – (UNC) Unified Coarse – (UN) Unified Constant.

These classifications are determined by the relationship of threads per inch to outer diameter.

Note: For further information on thread pitch, please refer to ISO standards handbook or H-28 handbook.

SAE Straight Thread Port (SAE J1926)

Parker straight thread fittings shown are for connection with the SAE straight thread port as shown here. Basic port dimensions are given in Table 31 below. This port is the same as MS16142. It is also similar to, but dimensionally not the same as MS 33649 and AND 10050.

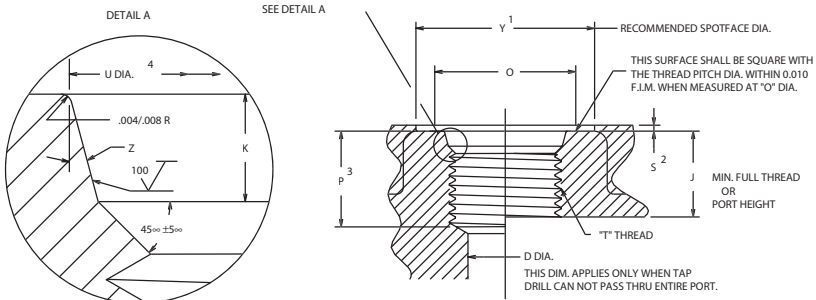

Figure 77

Table 31 SAE Straight Thread O-Ring Port Dimensions

Tube O.D.	Thread Size UNF-2B	D Min. Dia.	J Min. Full Thd. Depth	K +.015 -.000	O Min. Dia.	P Min. Tap Drill Depth	S Max	U +.005 -.000 Dia.	Y Dia.	Z +1 -1
1/8	5/16-24	0.062	.390	.074	.438	.468	.062	.358	.672	12
3/16	3/8-24	0.125	.390	.074	.500	.468	.062	.421	.750	12
1/4	7/16-20	0.172	.454	.093	.563	.547	.062	.487	.828	12
5/16	1/2-20	0.234	.454	.093	.625	.547	.062	.550	.906	12
3/8	9/16-18	0.297	.500	.097	.688	.609	.062	.616	.969	12
1/2	3/4-16	0.391	.562	.100	.875	.688	.094	.811	1.188	15
5/8	7/8-14	0.484	.656	.100	1.000	.781	.094	.942	1.344	15
3/4	1-1/16-12	0.609	.750	.130	1.250	.906	.094	1.148	1.625	15
7/8	1-3/16-12	0.719	.750	.130	1.375	.906	.094	1.273	1.765	15
1	1-5/16-12	0.844	.750	.130	1.500	.906	.125	1.398	1.910	15
1-1/4	1-5/8-12	1.078	.750	.132	1.875	.906	.125	1.713	2.270	15
1-1/2	1-7/8-12	1.312	.750	.132	2.125	.906	.125	1.962	2.560	15
2	2-1/2-12	1.781	.750	.132	2.750	.906	.125	2.587	3.480	15

Note: Tap drill lengths “P” given here require bottoming taps. Increase “P” as required for standard taps.

Note: Diameter “U” shall be concentric with thread pitch diameter within .005 FIM. It should be free from longitudinal and spiral tool marks.

Metric Threads (ISO 6149-2)

The following sections were prepared with the intention of explaining that NONE of them should be confused with a metric thread.

Please remember that a metric thread, be it parallel or tapered is designated as metric by the distance in millimeters from thread crest to crest. In the case of the parallel thread Figure 78 the O.D. is also expressed in millimeters.

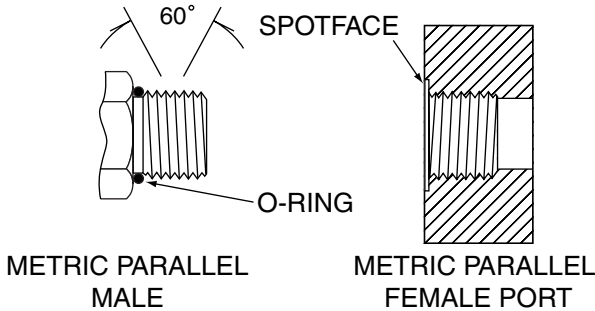
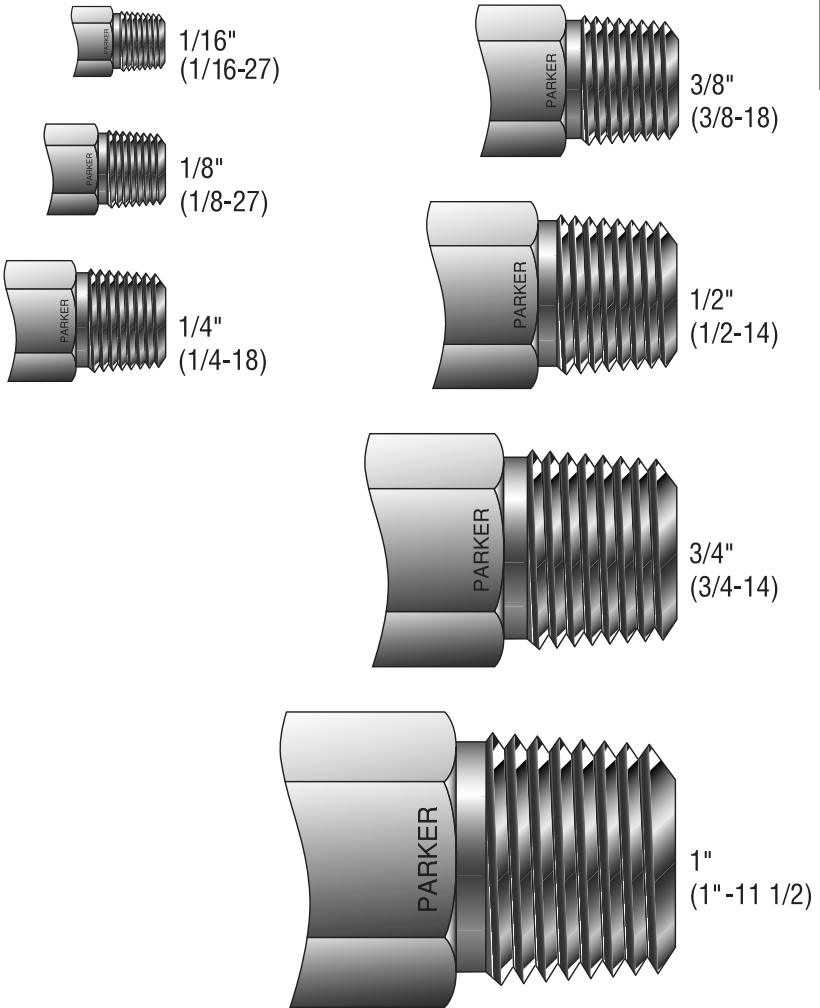

Figure 78

To assist you in determining the various types of threads, Parker has available the International Thread I.D. Kit/Bulletin 4303-B1. It includes calipers, international and screw thread pitch gauges.

Thread and Tube End Size Chart (U.S.A.)

NPT Thread



American Standard Pipe Thread (NPT)

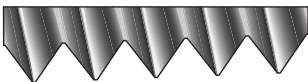

- 60° thread angle • Pitch measured in inches
- Truncation of root and crest are flat
- Taper angle 1°47'

Thread and Tube End Size Chart (International) Straight Thread

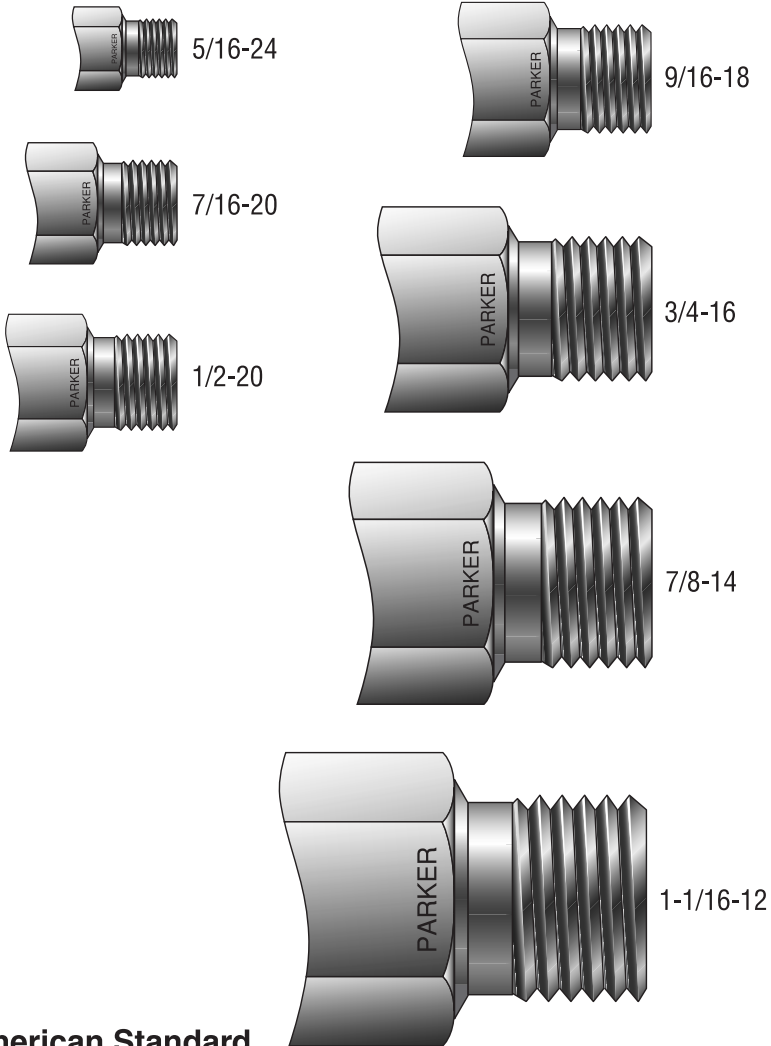

American Standard Unified Thread (Straight)

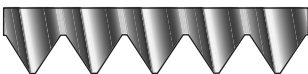

- 60° thread angle
- Pitch measured in inches
- Truncation of root and crest are flat
- Diameter measured in inches

Thread and Tube End Size Chart (U.S.A.)

Tubing O.D. Size

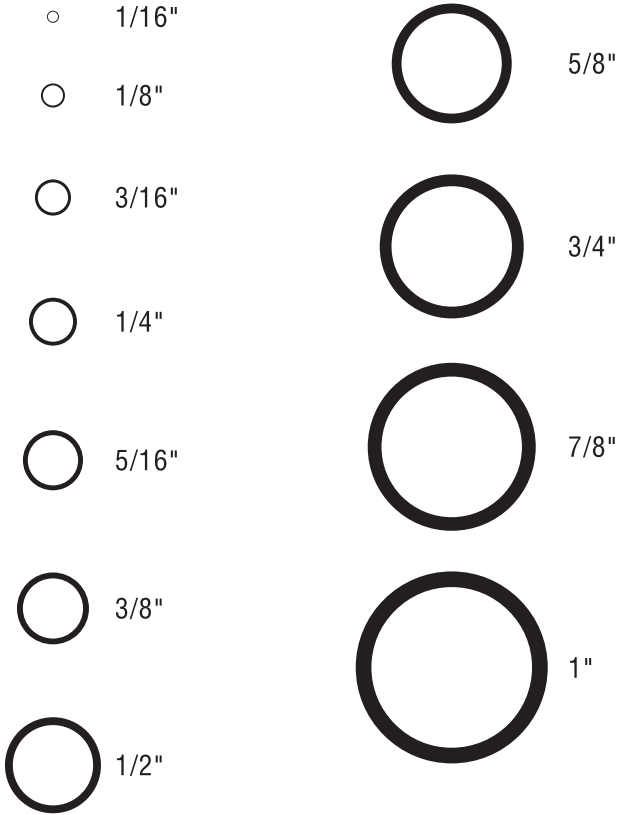

Installation

Pipe and Tube End Size Chart (U.S.A)

Tubeing O.D. Size

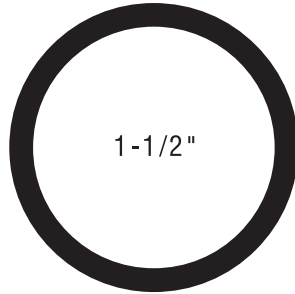
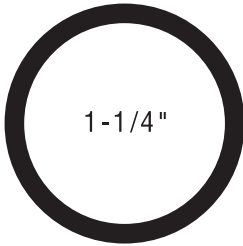

NPT Thread

1-1/4"
(1-1/4" - 11-1/2")



1-1/2"
(1-1/2" - 11-1/2")



Pipe and Tube End Size Chart (U.S.A)

Installation

Tubing O.D. Size

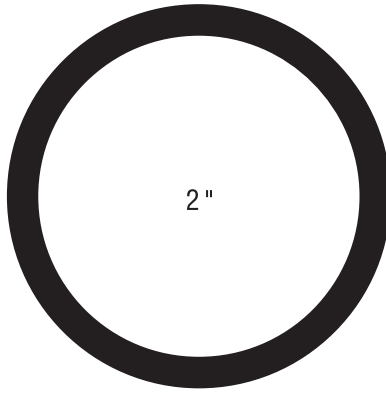

NPT Thread

2''
(2'' - 11-1/2'')



Thread and Tube End Size Chart (International)

BSPT Tapered Thread

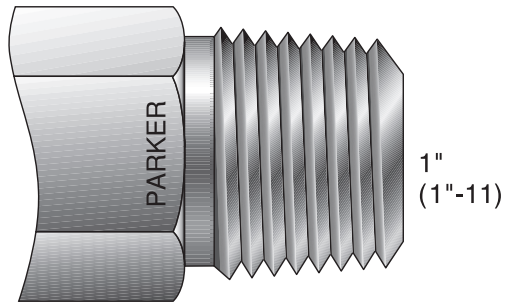
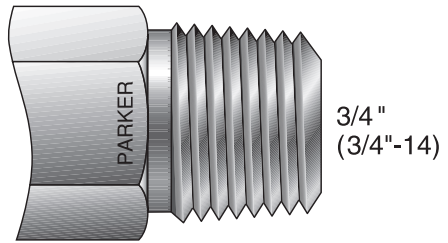
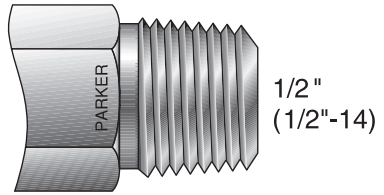
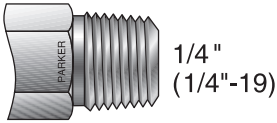
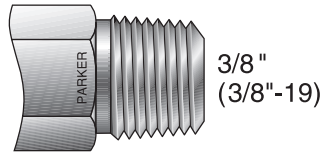
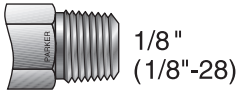

International Organization for Standards (ISO 7/1)

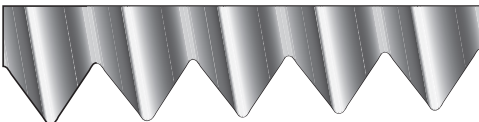

55° thread angle • Pitch measured in inches

- Truncation of root and crest are round
- Taper angle 1°47'

Thread and Tube End Size Chart (International)

BSPP Parallel Thread

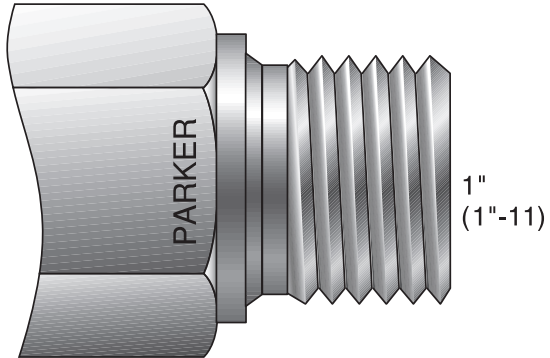
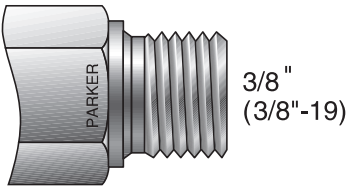
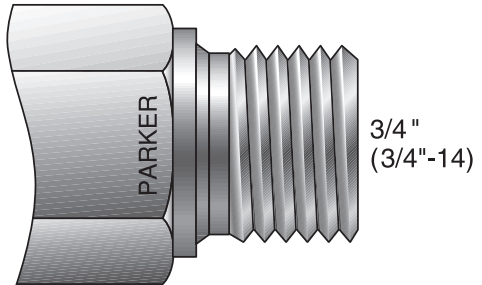
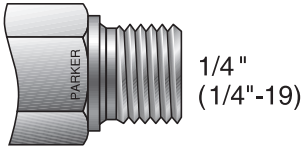
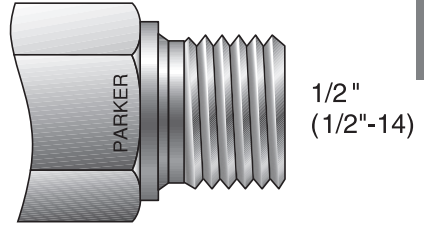
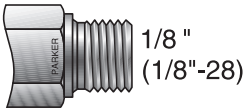

**International
Organization
for Standards
(ISO 228/1)**

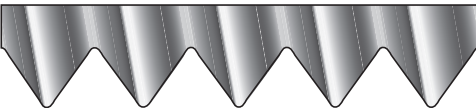

55° thread angle • Pitch measured in inches

- Truncation of root and crest are round
- Diameter measured in inches

Thread and Tube End Size Chart (International)

Tubing O.D. Size

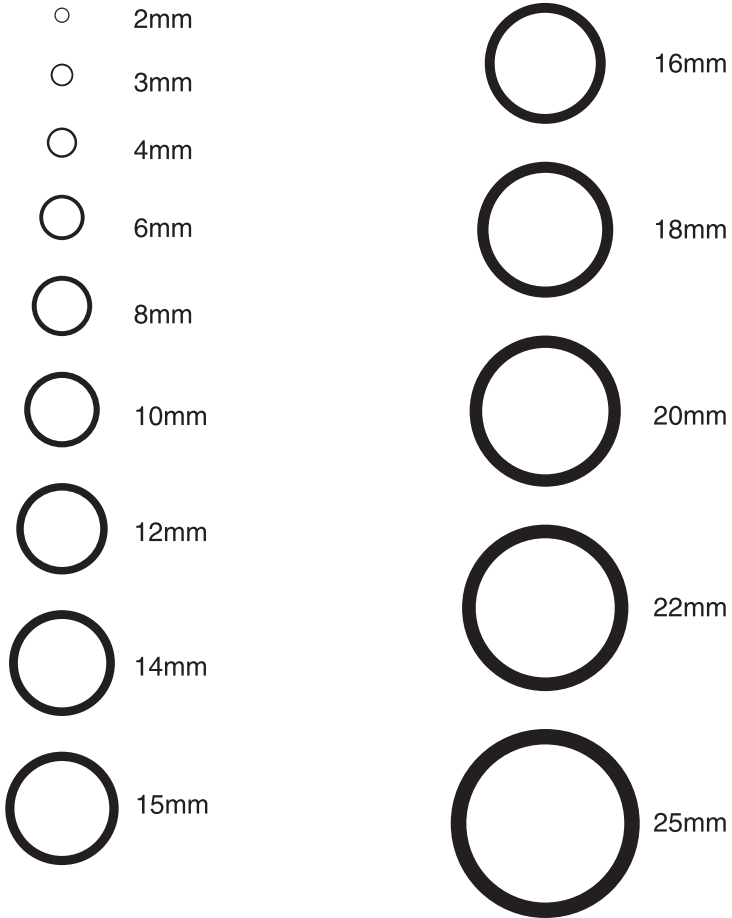

Pipe Data and Dimensions

Table 32

Pipe Size (Inches)	Schedule #	Iron Pipe Size	Dimensions		
			Outside Diameter (Inches)	Inside Diameter (Inches)	Wall Thickness (Inches)
1/8	–	–	0.405	0.307	0.049
	40	STD		0.269	0.068
	80	XS		0.215	0.095
1/4	–	–	0.540	0.410	0.065
	40	STD		0.364	0.088
	80	XS		0.302	0.119
3/8	–	–	0.675	0.545	0.065
	40	STD		0.493	0.091
	80	XS		0.423	0.126
1/2	–	–	0.840	0.710	0.065
	–	–		0.674	0.083
	40	STD		0.622	0.109
	80	XS		0.546	0.147
	160	–		0.466	0.187
–	XXS	0.252	0.294		
3/4	–	–	1.050	0.920	0.065
	–	–		0.884	0.083
	40	STD		0.824	0.113
	80	XS		0.742	0.154
	160	–		0.612	0.219
–	XXS	0.434	0.308		
1	–	–	1.315	1.185	0.065
	–	–		1.097	0.109
	40	STD		1.049	0.133
	80	XS		0.957	0.179
	160	–		0.815	0.25
–	XXS	0.599	0.358		
1-1/4	–	–	1.660	1.530	0.065
	–	–		1.442	0.109
	40	STD		1.38	0.140
	80	XS		1.278	0.191
	160	–		1.160	0.250
–	XXS	0.896	0.382		
1-1/2	–	–	1.900	1.770	0.065
	–	–		1.682	0.109
	40	STD		1.610	0.145
	80	XS		1.500	0.200
	160	–		1.338	0.281
–	XXS	1.100	0.400		
2	–	–	2.375	2.245	0.065
	–	–		2.157	0.109
	40	STD		2.067	0.154
	80	XS		1.939	0.218
	160	–		1.687	0.344
–	XXS	1.503	0.436		

Parker Needle Valves

Parker's Tube Fabrication Manual is designed to help the installer of an instrument tubing line or system. The Needle Valve section of this manual will provide the installer an overview of the various types of needle valves available for system design. Whether you want to isolate a line or process, regulate a line or divert a line in a system, there is a valve designed to do that.

Integral Bonnet Valve

Parker Integral Bonnet Valves are designed for positive leak tight shut-off and regulation of fluids in process, power, and instrumentation applications. With a wide variety of port sizes and styles, temperature capabilities ranging from -65°F to 450°F (-54°C to 232°C) and pressures to 5000 psig (345 bar), these valves provide the user with the utmost in flexibility when designing miniaturized tubing or piping systems.

Features

- ▶ Choice of three stem types:
 - R-Stem – All metal, blunt stem tip
 - N-Stem – All metal, tapered needle stem tip
 - K-Stem – PCTFE stem tip
- ▶ Differential hardness between the strain hardened stem and cold formed body threads provides improved cycle life
- ▶ Choice of PTFE packing or elastomeric O-ring stem seals
- ▶ 316 Stainless Steel, Steel, Brass and Monel® Alloy 400 construction
- ▶ Inline and angle patterns
- ▶ Wide variety of US Customary and SI ports
- ▶ Panel mountable
- ▶ 100% factory tested
- ▶ Optional color coded handles

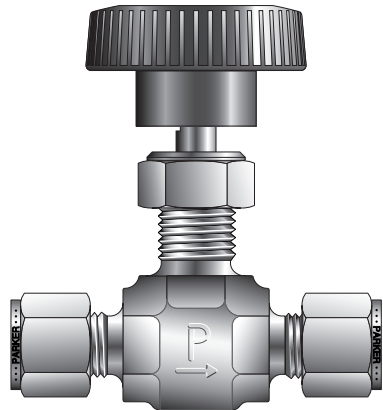

Model Shown: 4Z-V4LK-SS

Union Bonnet Valves

Parker Union Bonnet Valves have been engineered for use at pressures up to 6,000 (414 bar) and temperatures as high as 1,200°F (649°C). A non-rotating lower stem helps to extend packing life by removing rotation from the packing area. Stem packing below the threads isolates the thread lubricant from the flow, ensuring adequate lubrication regardless of the media.

Features

- ▶ Union bonnet design ensures high integrity seal under severe service applications
- ▶ Packing below the power threads protects thread lubricants from media and isolates the lubricants from the media
- ▶ Dust seal in the packing nut protects stem threads from external contamination
- ▶ Stem swivel above the packing eliminates entrapment area and increases packing life
- ▶ Choice of Grafoil® or PTFE packing
- ▶ Choice of Regulating or Blunt stem types. Blunt stem type helps combat wire draw which may occur when two phase flow is present (i.e. steam service)
- ▶ 316 stainless steel construction
- ▶ Wide variety of US Customary and SI ports
- ▶ Panel mountable
- ▶ 100% factory tested

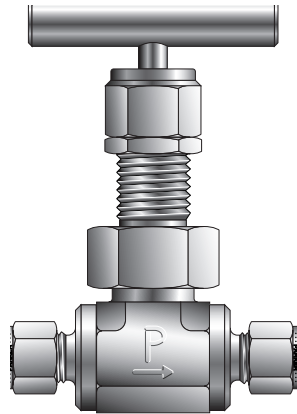

Model Shown: 4Z-U6LB-T-SS

Screwed Bonnet Needle Valves

Parker Screwed Bonnet Needle Valves are designed with packing below the stem threads and a two-piece stem. The packing below the threads protects the flow stream from thread lubricant contamination or washout and also protects the stem threads from potential damaging effects of the media. The two-piece stem produces a non-rotating lower stem for superior, repeatable sealing and reduced packing wear.

Features

- ▶ Packing below power threads protects thread lubricants from media and isolates the media from the lubricant for severe service applications
- ▶ O-ring dust seal in bonnet protects stem threads from external contamination
- ▶ Choice of two non-rotating stem types:
 - R-Stem – All metal, blunt stem tip
 - K-Stem – PCTFE stem tip
- ▶ Non-rotating lower stem extends packing and valve life
- ▶ 316 stainless steel construction
- ▶ Inline and angle patterns
- ▶ Wide variety of US Customary and SI ports
- ▶ Panel mountable
- ▶ 100% factory tested
- ▶ Optional color coded handles

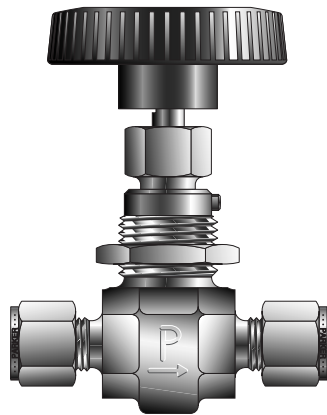

Model Shown: 4Z-NP6LK-SSP

Toggle Valves

Parker Toggle Valves are the right combination of performance and value for manual or pneumatic on-off control in moderate pressure and temperature applications. The manual version employs a toggle handle for quick action at pressures up to 300 psig (21 bar). Compact double acting, normally closed, and normally open pneumatically actuated versions of this valve are ideal for automatic control at pressures up to 600 psig (41 bar).

Manual Toggle Valve Features

- ▶ Quick acting
- ▶ Inline and angle patterns
- ▶ Available with CPI™, A-LOK®, male and female NPT end connections
- ▶ Panel mountable
- ▶ Color-coded handles
- ▶ 316 stainless steel and brass body construction
- ▶ Stem seal materials –
 - Fluorocarbon Rubber
 - Nitrile Rubber
 - Ethylene Propylene Rubber
 - Highly Fluorinated Fluorocarbon Rubber
- ▶ Optional handle positioners and anti-lock handles
- ▶ 100% factory tested

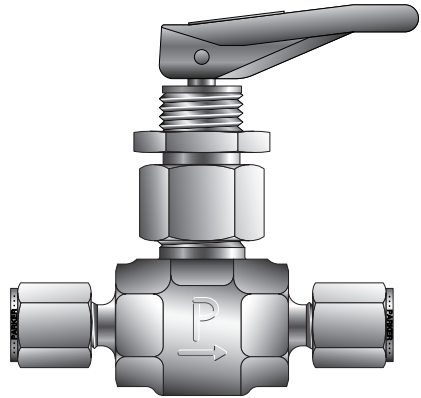

Model Shown: 4A-V4LQ-BP

Toggle Valves (Continued)

Actuated Valve Features

- ▶ Available in normally open, normally closed, and double acting models
- ▶ Inline and angle patterns
- ▶ Available with CPI™, A-LOK®, male and female NPT end connections
- ▶ Mounting bracket standard
- ▶ 316 stainless steel and brass body construction
- ▶ Stem seal materials –
 - Fluorocarbon Rubber
 - Nitrile Rubber
 - Ethylene Propylene Rubber
 - Highly Fluorinated Fluorocarbon Rubber
- ▶ 100% factory tested

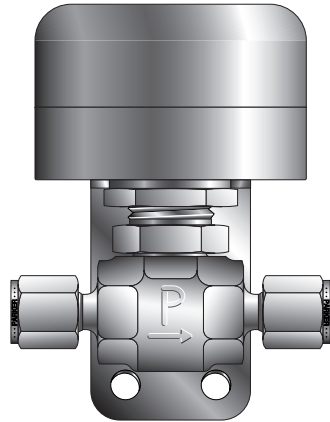

Model Shown:
M6A-V4LQ-BN-11AC-SS

Rising Stem Plug Valves

Parker Rising Plug and Gauge/Root Valves are available with a variety of seat and seal materials. They are screwed bonnet designs featuring bonnet lock plates. The valves provide a straight-through flow path in two orifice sizes. The valves utilize a non-wetted upper stem and a non-rotating lower stem in conjunction with a tapered seat for positive shut-off and long seat life, even in particulated media.

Features

- ▶ Bi-directional flow
- ▶ Roddable, straight through flow path
- ▶ Bonnet lock plate resists accidental bonnet disengagement
- ▶ Stem dust seal helps protect stem from external contamination
- ▶ Inlet side optional outlet – PVG 1/4" Female NPT – PVG 1/2" Female NPT
- ▶ Rugged 316 stainless steel barstock construction
- ▶ Panel mounting option
- ▶ Gauge port option
- ▶ 100% factory tested

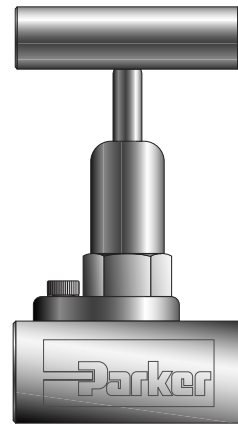

Model Shown:
4F-PV4DE-V-SS

Parker Ball Valves

Parker's Instrument Ball Valve section is designed to help the installer of an instrument tubing line or system to determine the correct valve. The Ball Valve section of this manual will provide the installer an overview of the various types of ball valves available for system design. Whether you wanted to isolate a line or process, divert or select a line in a system, there is a ball valve designed to do that.

Two-Way Ball Valves – up to 6000 psig

Parker manually, pneumatically, and electrically actuated two-way Ball Valves provide quick 1/4 turn on-off control of fluids utilized in process and instrumentation applications. A broad selection of valve body, seat, and seal materials provide a wide range of pressures and temperatures at which the valve may be used.

Features

- ▶ Free floating ball design provides seat wear compensation.
- ▶ Available in 316 stainless steel and brass construction. Monel® Alloy 400 and Hastelloy® C-276 construction available upon request.
- ▶ Micro-finished ball provides a positive seal.
- ▶ Straight through flow path for minimum pressure drop.
- ▶ Bi-directional flow.
- ▶ Wide variety of US Customary and SI ports.
- ▶ 90° actuation.
- ▶ Panel mountable.
- ▶ Adjustable PTFE stem seal can be maintained in-line.
- ▶ Handle indicates flow direction.
- ▶ Low operating torques.
- ▶ Positive handle stops.
- ▶ Color coded handles.
- ▶ Optional pneumatic and electric actuation.
- ▶ Optional live-loaded PTFE stem seals.
- ▶ Optional non-adjustable O-ring stem seals.
- ▶ Optional upstream and downstream drain models.
- ▶ Optional stainless steel and extended handles.

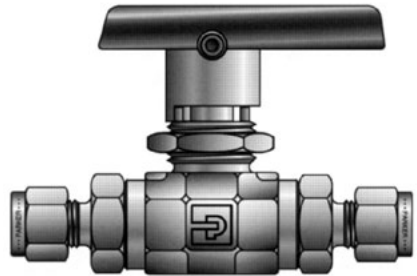

Model Shown: 4A-B6LJ-SSP

Three-Way Ball Valves – up to 6000 psig

Parker manually, pneumatically, and electrically actuated three-way Ball Valves may be used as diverting or selecting valves for fluids utilized in process and instrumentation applications. The standard three-way diverter valve is designed to accept media through the bottom port and direct it out of two outlet ports. When equipped with spring-loaded seats, the three-way valve may be used as a selector valve, alternately accepting media from either of two inlet sources (side ports) and directing it through a single outlet (bottom port).

Features

- ▶ Available in 316 stainless steel and brass construction. Monel® Alloy 400 and Hastelloy® C-276 construction available for Diverter Valves upon request.
- ▶ Micro-finished ball provides a positive seal.
- ▶ Wide variety of US Customary and SI ports.
- ▶ 180 degree actuation.
- ▶ Panel mountable.
- ▶ Adjustable PTFE stem seal can be maintained in-line.
- ▶ Handle indicates flow direction.
- ▶ Low operating torques.
- ▶ Positive handle stops.
- ▶ Color coded handles.
- ▶ Optional pneumatic and electric actuation.
- ▶ Optional live-loaded PTFE stem seals.
- ▶ Optional non-adjustable O-ring stem seals.
- ▶ Optional stainless steel and extended handles.

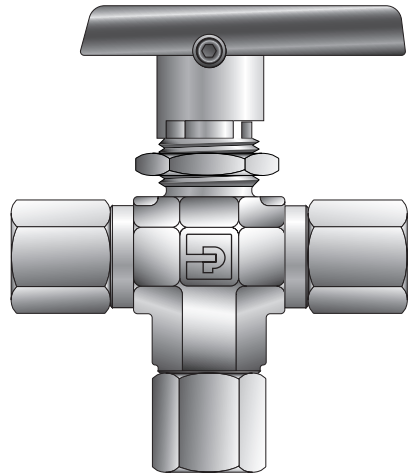

Model Shown: 4F-B6XJ2-BP

Rotary Plug Valves – up to 3000 psig

Parker Rotary Plug Valves provide positive leak tight shut-off, high flow capacity, and quick quarter-turn operation in a compact attractive package. The patented blow-out resistant seat design offers reliable sealing technology at all operating pressures. In addition to on-off actuation, the plug design allows forward flow throttling. A selection of valve seat and seal materials may be chosen for media compatibility and performance over a broad range of temperatures. The pressure balanced atmospheric seals are backed by PTFE rings to enhance their performance and increase cycle life.

Features

- ▶ Patented blow-out resistant seat design
- ▶ Pressures up to 3,000 psig (207 bar) CWP
- ▶ Quarter-turn operation
- ▶ Reliable simple design
- ▶ Straight-through flow
- ▶ Stainless steel and brass construction
- ▶ Nitrile, ethylene propylene, fluorocarbon, and highly fluorinated fluorocarbon rubber seats and seals
- ▶ PTFE back-up rings on atmospheric seals
- ▶ Low operating torque
- ▶ Minimum pressure drop
- ▶ Throttling capability
- ▶ Positive handle stops
- ▶ Color coded fracture resistant nylon handles with directional flow indication
- ▶ Easy to service
- ▶ 100% factory tested
- ▶ Options include lock-out devices, downstream venting, and both stainless steel and T-bar handles

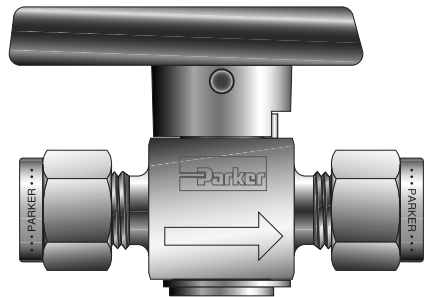

Open



Closed



Model Shown: 4A-PR4-VT-SS

U.S. Patent 5,234,193

Barstock Ball Valves – up to 3000 psig

Parker Barstock Ball Valves, with their rugged compact design, offer positive shut off or directional control of fluids in process, power and instrumentation applications. The unique one piece seat/packing design insures excellent sealing characteristics while accommodating a superior temperature range and cycle life.

These valves are available in two-way and three-way configurations, brass and stainless steel construction, with a wide variety of port connections. Also, all ports are suitable as inlets to full operating pressure of the valve.

Features

- ▶ One piece seat/packing design
- ▶ Broad temperature range
- ▶ Coated metal inserts
- ▶ One piece stem/ball
- ▶ Wide variety of US Customary and SI ports
- ▶ Panel mountable to 1/4" thickness
- ▶ Bi-directional flow
- ▶ Handle indicates direction of flow
- ▶ Full operating pressure at any port
- ▶ Positive handle stops
- ▶ Color coded handles
- ▶ 100% factory tested
- ▶ Vent option
- ▶ Manual, electric or pneumatic actuation
- ▶ Leak-tight center-off position on three-way valves

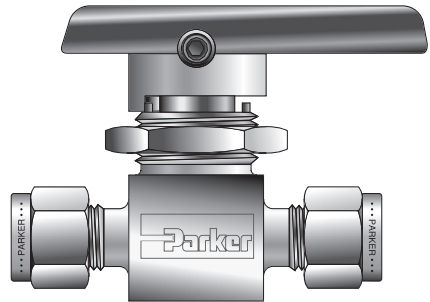

**Model shown: 4A-MB6LPFA-SSP
Two-Way In-Line**

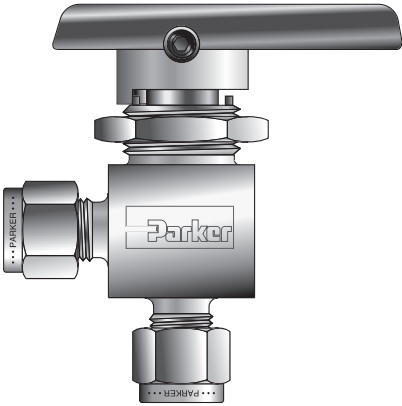

Model shown: 4A-MB6APFA-SSP
Two-Way Angle

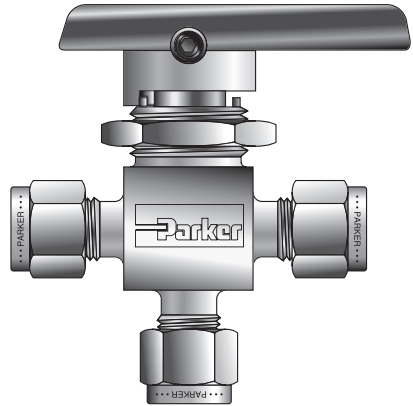

Model shown: 4A-MB6XPFA-SSP
Three-Way

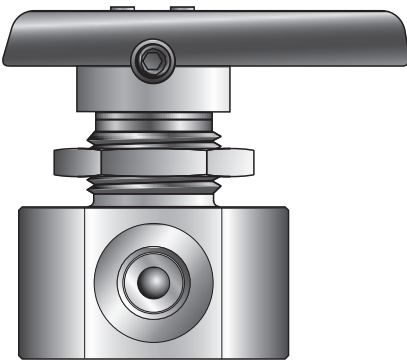
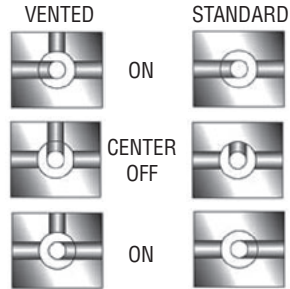
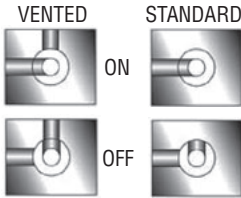

Four-Way

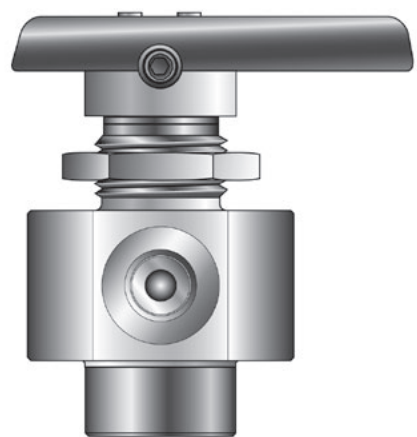
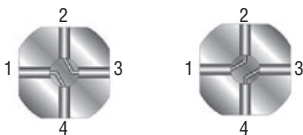

Five-Way



High Pressure Ball Valves – up to 10,000 psig

Parker High Pressure Series Ball Valves provide reliable shut-off or switching functions. The upper and lower trunnion bearings enhance the resistance of the trunnions against seizure, and increase the valve life in extreme applications. The compact and rugged design employs spring-loaded seats for high cycle life and low operating torques at pressures up to 10,000 psig (689 bar).

Features

- ▶ PEEK trunnion bearings for longer cycle life
- ▶ Two-way and three-way designs
- ▶ Compact FNPT version for tight work areas
- ▶ Blow-out resistant two-piece ball/stem
- ▶ Full operating pressure at any port
- ▶ Low operating torque
- ▶ Manual, electric or pneumatic actuation
- ▶ Panel mountable to 3/8" (9.6mm) thickness
- ▶ No packing to adjust
- ▶ Color coded fracture resistant handles
- ▶ Handle indicates direction of flow
- ▶ Positive handle stops
- ▶ Wide variety of US customary and SI ports
- ▶ Top of stem marked to indicate flow direction
- ▶ 100% factory tested
- ▶ Compact package
- ▶ Heat code traceability

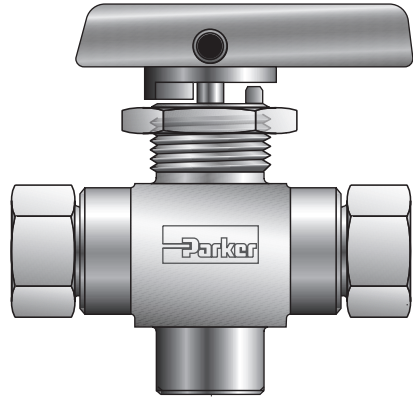

Model shown: 4F-HB4XPKR-SSP

High Pressure Ball Valves – up to 20,000 psig

Parker High Pressure series manually, pneumatically and electrically actuated two-way and three-way ball valves are designed for 1/4 and 1/2 turn media shutoff or switching applications up to 20,000 psi. Our trunion style ball design and spring loaded seats make the MPB series ideal for severe service applications. The end connector design enables a variety of end connections and combinations for specific customer applications.

Two Way Ball Valves

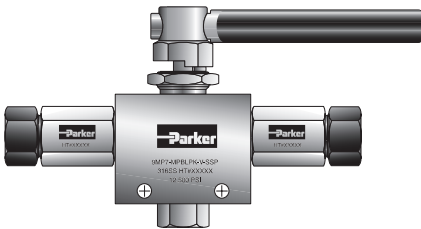

**.187 Orifice
(Standard)**

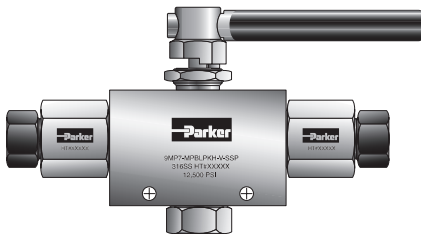

**.375 Orifice
(High Flow)**

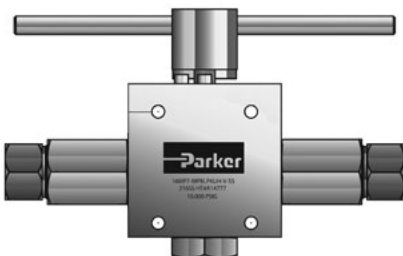

**.500 Orifice Two-Way
(UltraHigh Flow)**

Three Way Ball Valves

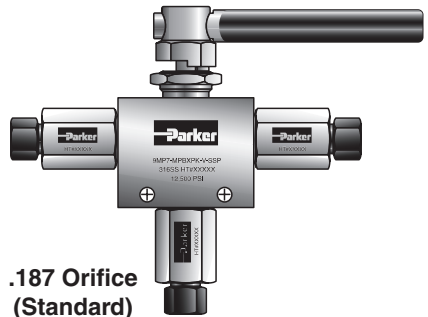

**.187 Orifice
(Standard)**

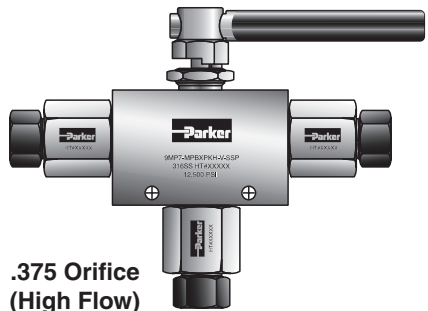

**.375 Orifice
(High Flow)**

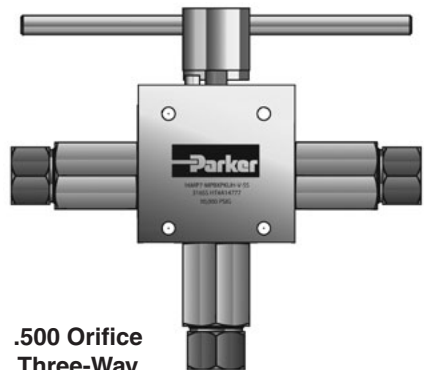

**.500 Orifice
Three-Way**

Swing-Out Ball Valves – up to 2500 psig

Parker's three-piece SWB Series Ball Valves are durable valves that can handle the pressure and piping loads. The center section can swing out to quickly and easily replace seats, seals and the ball without major disruption to the piping system.

Features

- ▶ Ultra low internal volume
- ▶ Free floating ball design allows for seat wear compensation
- ▶ Self-compensating stem seal
- ▶ Spring-loaded seats
- ▶ Blow out resistant stem
- ▶ Fully enclosed body bolting
- ▶ Four bolt construction
- ▶ ISO-type actuator mounting design
- ▶ Pneumatic and electric actuation options
- ▶ 100% factory tested

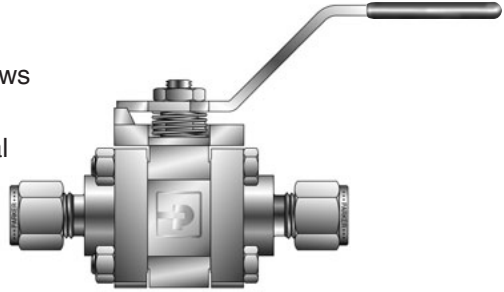

Model Shown: 8Z-SWB8L-RT-BN-SS

Parker Check Valves and Filters

Parker's line of Check and Filter valves are designed to help the installer of an instrument tubing line or system achieve uni-directional flow or filtration in their system. The check and filter valve section of this manual will provide the installer an overview of the various types of valves available for system design. Check valves have cracking pressures ranging from 1/3 to 100 psi and up to 6000 psi valve ratings. Filter valves provide filtration from 1 to 100 micron, and down to 450 micron with a wire cloth element option.

C Series Check Valves

Parker C Series Check Valves are designed for uni-directional flow control of fluids and gases in industries such as chemical processing, oil and gas production and transmission, pharmaceutical, pulp and paper, power and utilities.

Features

- ▶ Resilient, custom molded, blow-out resistant seat design
- ▶ Back stopped poppet minimizes spring stress
- ▶ 100% factory tested for both crack and reseal
- ▶ Cracking pressures include: 1/3, 1, 5, 10, 25, 50, 75, and 100 psi.
- ▶ Port connections include male and female NPT, CPI™, A-LOK®, UltraSeal, VacuSeal, BSP, SAE and Seal-Lok®
- ▶ Heat code traceability

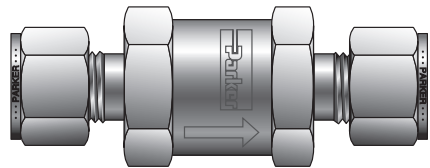

Model Shown: 4Z-C4L-1-SS

CB and CBF Series Check Valves

Parker CB and CBF Series Check Valves are designed for uni-directional flow control of fluids and gases. The unique floating ball valve design handles demanding services in power generation, chemical processing, oil/gas production, and other demanding applications. The CB/CBF Series are specifically designed to reduce check valve maintenance and performance requirements on dual fuel turbines. Specific issues include, but are not limited to seat leakage, coking, repair and maintenance. All of these issues directly affect turbine efficiency, impacting operating costs. The advanced seat materials of the CB/CBF Series Check Valves are particularly suited for higher temperature applications requiring high integrity leak rates and re-sealing capabilities.

Features

- ▶ Rugged and reliable floating ball valve seat design optimizes sealing characteristics while minimizing effects of coking.
- ▶ Optional hard PTFE coated ball cage resists poppet “stick” commonly experienced with fuel oil coking.
- ▶ Fully field serviceable with Parker rebuild kits. Replace seats in minutes without special tools.
- ▶ Advanced reinforced PTFE copolymer seat materials designed by Parker for demanding applications such as air purge and fuel oil.
- ▶ Integral “last chance” filter option for seat and nozzle protection.
- ▶ To even further reduce turbine downtime during repairs, utilize Parker’s metal flexible hoses.



CB Series Check Valve



CBF Series Filter Check Valve

CO Series Check Valves

Parker CO Series Check Valves are designed for uni-directional flow control of fluids and gases in industries such as chemical processing, oil and gas production and transmission, pharmaceutical, pulp and paper, power and utilities. The CO Series Check Valve is particularly suitable for applications requiring high integrity leak rates and re-sealing capabilities.

Features

- ▶ Seal integrity across the seat and to atmosphere is tested to 4×10^{-9} std atm-cc/sec (4×10^{-10} kPa – L/sec) for the CO4L with fluorocarbon rubber seals. All other sizes and seal materials are tested to 1×10^{-5} std atm-cc/sec (1×10^{-6} kPa – L/sec).
- ▶ Special seat seal design provides a repeatable high integrity seal and accurate cracking pressures
- ▶ 100% factory tested. Cracking pressures include: 1/3, 1, 5, 10, 25, 50, 75, and 100 psi.
- ▶ Valves are available with male and female NPT, CPI™, A-LOK®, UltraSeal, male and female VacuSeal, and Tube Adapter
- ▶ Heat code traceability
- ▶ Color coded identification labels indicate seal material

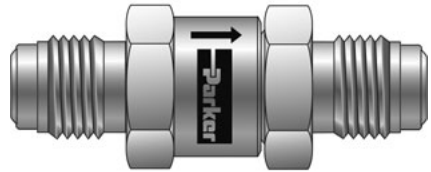

Lift Check Valves

Parker's LC-Series Lift Check Valve has been designed for a wide variety of temperature extremes found in power, chemical, petrochemical, oil & gas, and laboratory applications. The LC-Series, ideal for liquid service, has been designed to prevent flow in the reverse direction to within 99.9% of forward flow. The gravity assisted poppet uses back pressure to achieve a seal.

Features

- ▶ Wide temperature range
- ▶ Variety of end connections available
- ▶ Compact design
- ▶ Rugged, forged body construction
- ▶ Stainless steel construction

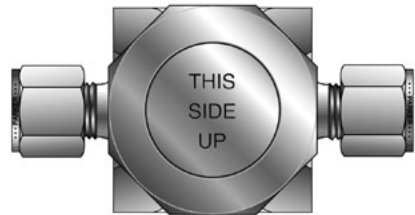
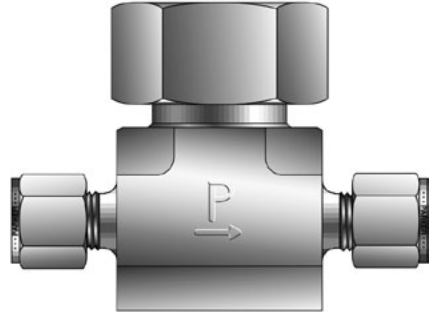

Note: Valve must be mounted in proper orientation.

MPC and MPCB Series Check Valves

Parker MPC and MPCB series check valves are designed for uni-directional flow control of fluids and gases up to 15,000 psi.



Ball Check Valves



Poppet Check Valves

Inline Filters

Parker F Series Inline Filters are designed for protection of instrumentation systems from undesirable materials. Component changes or repair and maintenance can admit dirt, chips, scale, or other contaminants to the small bore tubing.

Features

- ▶ Compact inline design with large filtration area
- ▶ Stainless steel and brass construction
- ▶ Replaceable sintered 316 stainless steel filter element
- ▶ Standard sintered metal micron ratings: 1, 5, 10, 50, and 100
- ▶ Optional 250 and 450 micron wire cloth filter elements
- ▶ Port connections include male and female NPT, CPI™, A-LOK®, UltraSeal, VacuSeal, BSP, SAE, and Seal-Lok®
- ▶ Heat code traceability

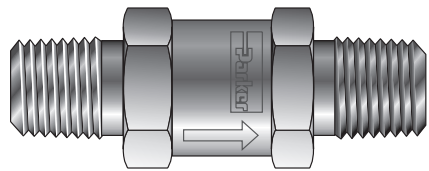

Model shown: 4M-F4L-100-BN-SS

Tee Filters

Parker FT Series Tee Filters are designed for protection of instrumentation systems from undesirable materials. Component changes or repair and maintenance can admit dirt, chips, or other contaminants to the small bore tubing.

Features

- ▶ Filter element replacement achievable without removing filter from installation
- ▶ Compact, high strength forged body design with effective filtration areas of:
 - FT4 – 1.57 sq in (1013 sq mm)
 - FT8 – 2.53 sq in (1632 sq mm)
- ▶ Stainless steel and brass construction
- ▶ Standard sintered metal micron ratings: 1, 5, 10, 50, and 100
- ▶ Optional 250 and 450 micron wire cloth filter elements
- ▶ Optional bypass enables a continuous self cleaning flow around the element
- ▶ Port connections include male and female NPT, CPI™, A-LOK®, UltraSeal, and VacuSeal

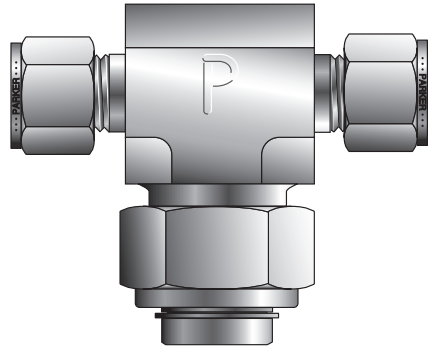

Model Shown: 4Z-FT4-10-BN-SS

MPF Series Filters

Parker MPF series filters utilize sintered stainless steel filter discs to trap particles from 0.5 to 100 micron sizes. Inline filters help protect valuable equipment in the process line.



Inline Filters

Relief Valves

Parker RH4 Relief Valves are designed such that when the upstream pressure exceeds the closing force exerted by the spring, the lower stem opens, permitting flow through the valve. Flow through the valve increases proportionately to the increase in upstream pressure.

Features

- ▶ Pressure settings are externally adjustable while the valve is in operation. Eight different spring ranges provide greater system sensitivity and enhanced performance.
- ▶ Captured molded seat design is blow-out and chip resistant.
- ▶ Manual Override option with positive stem retraction is available for pressures up to 1500 psig (103 bar). This option permits the user to relieve upstream pressure while maintaining the predetermined cracking pressure.
- ▶ Color coded springs and labels indicate spring cracking range.
- ▶ Lock wire feature secures a given pressure setting.

Model Shown:
4M4F-RH4A-VT-SS-MN-K2



Valves

Model Shown:
4A-RH4A-BNT-SS-K1

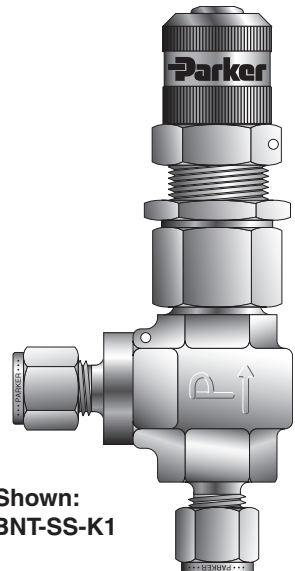

Relief Valves

Parker RL4 Relief Valves are designed such that when the upstream pressure exceeds the closing force exerted by the spring, the lower stem opens, permitting flow through the valve. Flow through the valve increases proportionately to the increase in upstream pressure.

Features

- ▶ Pressure settings are externally adjustable while the valve is in operation. Seven different spring ranges provide greater system sensitivity and enhanced performance.
- ▶ Manual override option with positive stem retraction is available for the full working pressures range. This option permits the user to relieve upstream pressure while maintaining the predetermined cracking pressure.
- ▶ Color coded springs and labels indicate spring cracking range.
- ▶ Back pressure has minimum effect on cracking pressure.
- ▶ Lock wire feature secures a given pressure setting.



Model Shown:
4M4F-RL4A-VT-SS-MN-KD

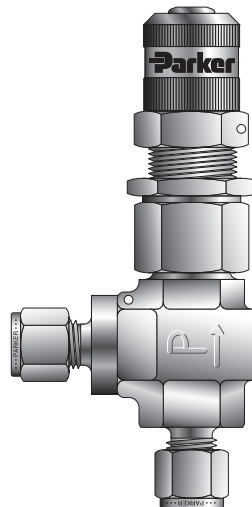

Model Shown:
4A-RL4A-BNT-SS-KC

Bleed Valves

Parker BV Series Bleed Valves are designed for use on products such as multi-valve manifolds or gauge/root valves. Functionally, the valve vents line pressure either to atmosphere or to containment when used with the optional barbed vent tube. Generally, bleed valves are used whenever an instrument is removed from a system or to assist in the calibration of control devices. The BV Series is also recommended for use in bleeding hydraulic systems.

Features

- ▶ Available in stainless steel, carbon steel and Alloy N24135
- ▶ Vent tube directs excess gas or liquid from system lines
- ▶ Chrome plated stem provides extended cycle life with improved sealability
- ▶ Positive stop/vent tube design prevents accidental removal of the stem
- ▶ Compact design
- ▶ Wrench actuation
- ▶ Available in a variety of end configurations including male pipe and SAE ports
- ▶ 100% factory tested
- ▶ Barbed vent tube option enables containment of vented media
- ▶ Optional T-bar handle for wrench-less actuation

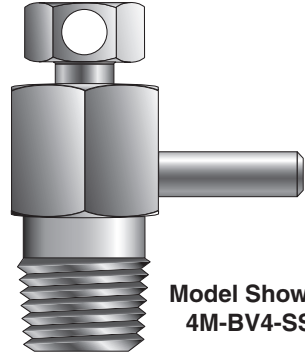

**Model Shown:
4M-BV4-SS**

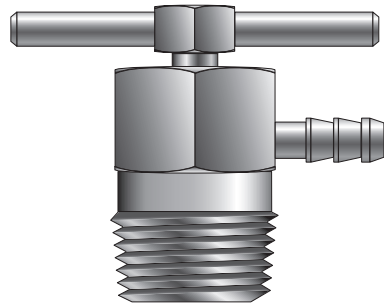

**Model Shown:
8M-BV8-SS-BVT-T**

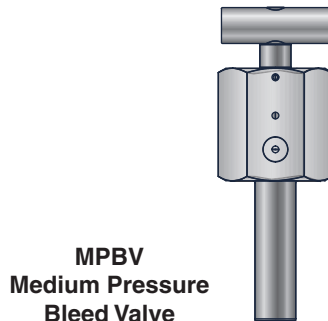

**MPBV
Medium Pressure
Bleed Valve**

Purge Valves

Parker PG Series Purge Valves may be utilized as either bleed, purge, or drain valves. The compact valve requires only a quarter turn with a wrench from finger-tight to ensure a leak-tight seal on the first make-up. Additional wrenching ensures a leak-tight seal up to the rated pressure.

Features

- ▶ A 0.055 inch (1.4 mm) diameter vent hole in the cap bleeds, drains, or purges system pressure
- ▶ Hex cap permits finger-tight or wrench assisted closure
- ▶ Crimped cap resists accidental disassembly
- ▶ A variety of body styles offers system design flexibility, reduced space requirements, and helps to eliminate leak paths
- ▶ Available in a variety of end configurations including: CPI™, A-LOK®, male and female NPT, SAE, and Tube Adapter connections
- ▶ 100% factory tested
- ▶ Optional PTFE Ball requires only finger-tight torque to achieve a leak-tight seal

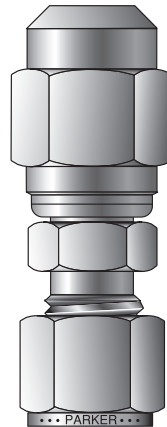

Model Shown: 4Z-PG4L-SS

Available Purge Valve Models

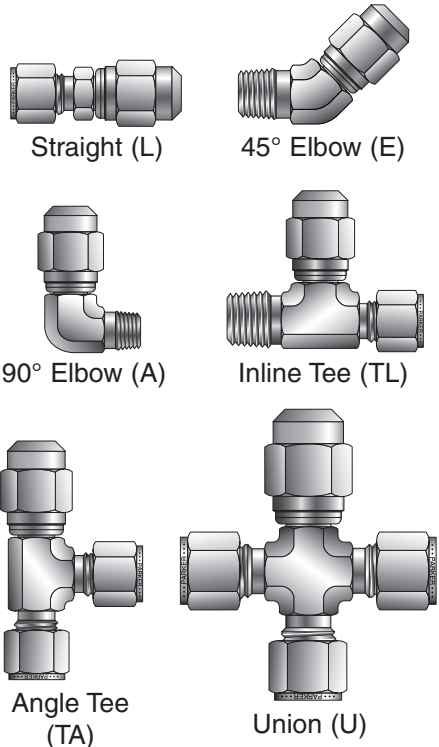

Parker Metering Valves

Parker's line of Metering Valves are designed to help the installer of an instrument tubing line or system. The Metering Valve section of this manual will provide the installer an overview of the various types of metering valves available for system design. There is a range of metering valves designed to provide accurate and staple control of flow rates.

Metering Valves

The Parker NS Series of metering valves are designed to provide accurate and stable control of flow rates in analytical, instrumentation, and research applications. A variety of connection sizes, body patterns and materials of construction provide considerable application versatility. For higher flow rates, refer to the NM and NL Series of metering valves.

Features

- ▶ Precision tapered valve stem accurately controls flow
- ▶ Brass or 316 SS forged body construction
- ▶ Panel or in-line mounting
- ▶ Positive handle stop prevents overtightening
- ▶ Angle or in-line patterns
- ▶ Valve stem threads not in contact with process fluid
- ▶ 100% function tested
- ▶ Optional stem seals and handles



Model Shown: 2A-NSL-BN-SS-F

Metering Valves

The Parker NM and NL Series of metering valves provide higher flow rates than the NS Series of metering valves and retain most of the features found in the NS Series.

Features

- ▶ Precisely tapered valve stem accurately controls flow
- ▶ Brass or 316 SS forged body construction
- ▶ Panel or in-line mounting
- ▶ Angle or in-line patterns
- ▶ Valve stem threads not in contact with process fluid
- ▶ 100% function tested
- ▶ Optional stem seals and handles

**Model Shown:
2A-NML-V-SS-K**

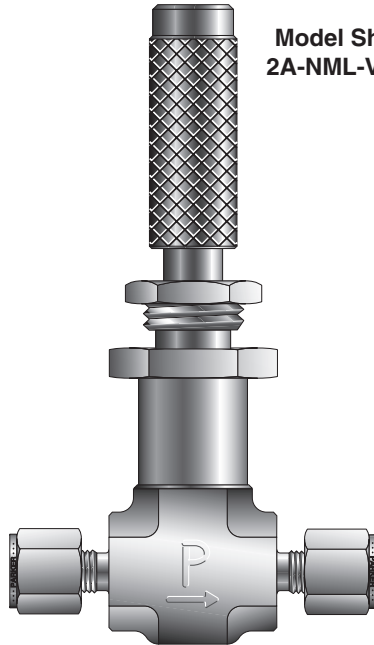

**Model Shown:
4A-NLL-V-SS-V**

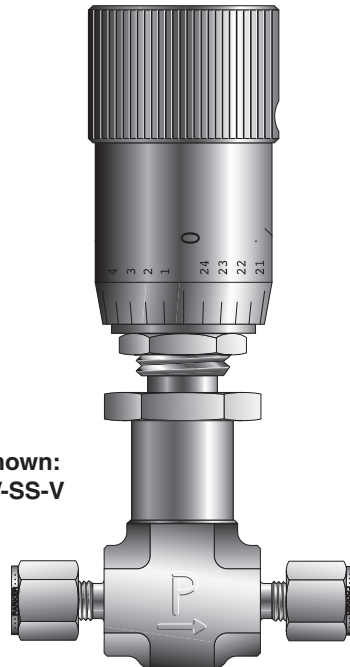

Optional Handles for NM and NL Series

Knurled (K) and Knurled with Slot (KS)



- Knurled K handle for ease of actuation
- Knurled with Slot (KS) adds a screw-driver slot across the top for locations where handle access is difficult

Vernier (V)



- Precision graduated aluminum alloy permits repeatable flow settings
- Resolution to 1/25th turn

Precision Adjustment (F)



- Adjustable torque handle for precise positioning
- Knurled metal with two top mounted adjustment screws
- NS Series only

Valves

Handle Options for HR Series

Knurled (K)



Knurled ABS molded handle provides ease of actuation

Turns Counter (TC)

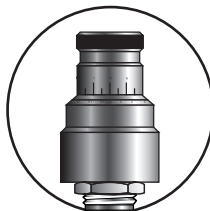

Graduated black-anodized aluminum alloy handle provides a readable count of turns open

Slotted Stem (NS)

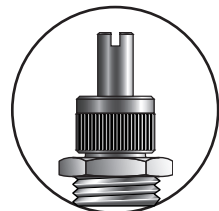

Screwdriver slot on top of stem may be used for inaccessible locations or tamper resistance

Parker HR Series Metering Valves provide the highest degree of precision metering for moderate pressure applications. A choice of seven precision ground, tapered flat, non-rotating and non-rising valve stems enable repeatable metering at flow capacities as low as 0.0004 CV. With 15 stem turns, this valve offers the ultimate in precision flow control. This series also features shut-off capability not found in most metering valves.

Features

- ▶ Bubble tight shut-off
- ▶ Special fine pitch thread with 15 turn resolution is isolated from contact with process fluids
- ▶ Non-rotating/non-rising valve stem design provides smooth, non-reversing flow characteristics
- ▶ Seven optional valve stem tapers
- ▶ Special orifice liner assures long life
- ▶ Panel or in-line mounting
- ▶ Angle or in-line patterns
- ▶ Brass or 316 SS forged body construction
- ▶ 100% function tested for actuation and shut-off

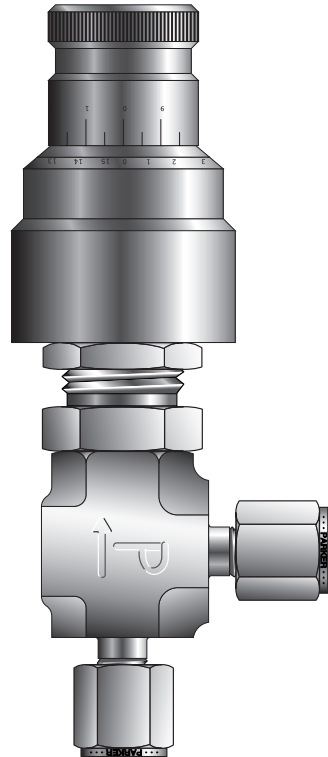

Model Shown: 2A-H0A-NE-SS-TC

Parker Fittings

Parker's line of Instrument Fittings includes a wide variety of styles, sizes and end configurations. These include both single ferrule and double ferrule , instrumentation tube fitting designs. The installer can determine the best component to install in the system being designed or built. In addition, there is an overview of pipe, weld and medium pressure fittings to match the installer's requirements.

CPI™/A-LOK® Fittings

Parker CPI™ /A-LOK® fittings consists of precision engineered parts designed to provide secure leak-proof joints capable of satisfying high pressure, vacuum and vibration applications.

Parker Instrumentation Tube Fittings are supplied complete and ready to use. The ferrule(s) swage onto the tube as it moves down the body seat creating a pressure/vacuum-tight seal on both tube and body by the interface pressure and surface finish of mating components. The Parker Suparcase® ferrule (back-ferrule only on A-LOK®) creates a strong mechanical hold on the tube.

CPI™

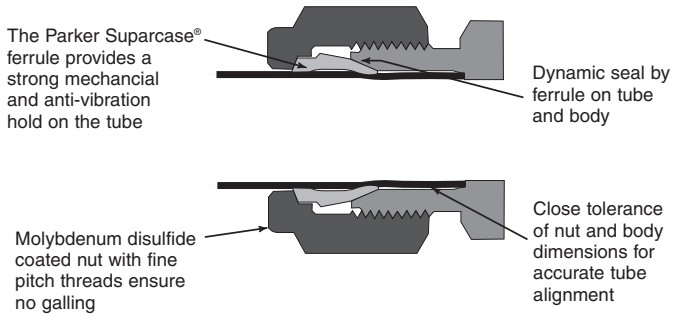

A-LOK®

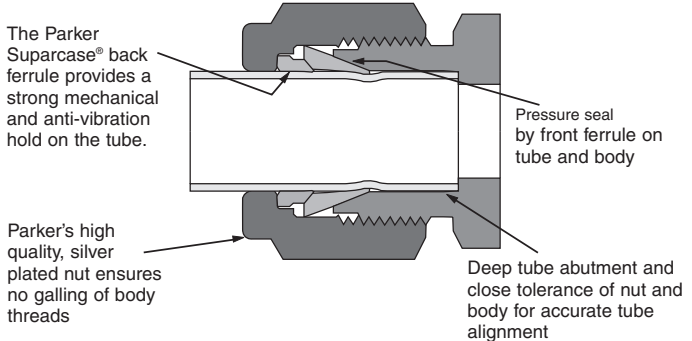

MPI™ Fittings

Parker Hannifin MPI™ Fittings are engineered and manufactured to provide secure, tight, and leak-resistant connections throughout industry, including off-shore oil and gas exploration platforms, research labs, and other facilities that require operating pressures in the range of 6,000 to 15,000 psi.

MPI™ Fittings are ideally suited to handle liquids, gases, or chemicals and can be used on a wide variety of tubing materials including cold drawn – 1/8 hard (unannealed) tubing or instrument grade thick-walled annealed stainless steel. Every Parker MPI™ Fitting is supplied complete and ready to install.

Advanced Features

Every MPI™ Fitting has the features shown below:

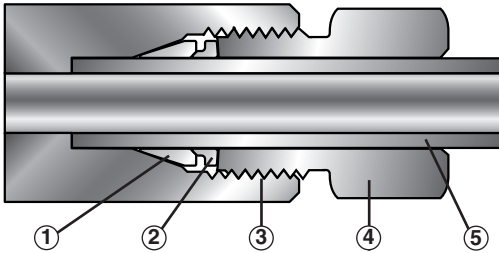

1. Front ferrule with corrosion-resistant Parker *Supercase*® forms a tight pressure seal between the body and ferrule in a second strong mechanical hold on the tube.
2. Rear ferrule with corrosion-resistant Parker *Supercase*® provides a strong mechanical hold on the tube.
3. Longer thread area for improved resistance to pressure and load on the ferrules.
4. Molybdenum disulfide-coated inverted nut helps prevent galling, provides easier assembly, and permits multiple remakes.
5. Long tube-support area improves resistance to vibration and line loads.

Instrument Pipe Fittings

Parker Instrumentation Pipe Fittings are designed as leak-free connections for process, power, instrumentation and general plumbing applications. They are manufactured to the highest quality standards and are available in broad ranges of sizes, materials and configurations.

Parker Instrumentation Pipe fittings are made at the Instrumentation Connectors Division of Parker Hannifin in Huntsville, Alabama where strict adherence to quality control programs are maintained. These quality standards are incorporated in a total efficiency program called Parker Targets.

The Parker Targets Program is a measure of the efficiency with which the company transforms materials, employee efforts, machinery and information into customer-satisfying products and services. Consequently, Instrumentation Pipe fittings as products of Parker Targets effectively guarantee to customers that they are receiving the highest quality fittings available.



ISO Conversion Fittings

Parker ISO Conversion Fittings are designed to the highest quality standards to allow connections between components and systems which use both NPT and ISO Thread configurations. Conversion fittings are maintained under strict quality control programs.

Design

Parker ISO Conversion Fittings are designed to the most commonly used ISO thread forms. These thread forms are used where pressure tight joints are either made on threads utilizing a thread sealant or where pressure tight joints utilize a peripheral seal on the face of the mating component.

Welded Fittings

In the chemical industry, process pressures are climbing higher and higher. The utility field, with its high steam pressures and hydraulic and pneumatic shutdown systems, demands the utmost in reliability. Nuclear power plants with their "hot" materials also have massive reliability problems. Such problem areas have given rise to the increased use of the permanent-weld-type tube fittings which provide a sturdy, tight integral line system that remains unaffected by shock, vibration or thermal distortion. The Parker Weld-lok® line of permanent socket weld tube fittings meets the most exacting requirements of any system.

Design Specifications

The Weld-lok® fitting has been designed and tested in accordance with ANSI B16.11, which covers "Forged Steel Fittings Socket Welded and Threaded." Our design parallels the Schedule 80, 3000-pound fitting pressure class, and is compatible with O.D. tube wall thickness meeting the related (3000-psi pipe class) pressure requirements. Strong, full section forgings are used for all "shape" fittings.



User Specification Requirements

The 316 stainless steel Weld-lok® fittings fully conforms to the applicable specifications covered in:

- ANSI B31.1 "Power Piping"
- ANSI B31.7 "Nuclear Power Piping"
- Section III, "Nuclear Power Plant Component," ASME Boiler and Pressure Vessel Code

Customer Specials may be quoted through the Parker Quick Response Department.

Tubing

Parker's line of tubing is provided in both domestic and non-domestic versions. Both meet the various industry specifications, such as ASME, ISO 9001, QS-9000, PED 97/23/EC, JIS, TUV and LRQA.

Table 33 Features and Benefits of Parker Tubing

Features	Benefits
Weldability	Controlled and consistent quality to provide easy welding
Plugged ends	Protection during transit and from environmental contamination
Strictly controlled ovality, concentricity and close tolerances	Superior performance in a wide variety of system applications, temperatures and pressures
Made under high quality standards	Meets ASME, ISO 9001, QS-9000, PED 97/23/EC, JIS, TUV and LRQA requirements for tubing
Parker "branded" on P1 non-domestic and P2 domestic tubing	Assures installers that tubing as well as tube fittings and valves – have been qualified by Parker Hannifin

- ▶ Available in sizes from 1/8" to 1" outside diameter
- ▶ Marked to indicate size, material, specifications and heat number
- ▶ Parker "branded" for quality assurance



Table 34 Chemical Composition

Element	Material Grade 316/316L Composition
Chromium	16.0-18.0
Nickel	10.0-14.0
Molybdenum	2.00-3.00
Manganese	2 max
Silicon	1 max
Carbon	0.035 max
Sulfur	0.03 max

Sales Offices Worldwide

Parker Hannifin Corporation

Instrumentation Products Division
1005 A Cleaner Way
Huntsville, AL 35805
USA
phone 256 881 2040
fax 256 881 5072
www.parker.com/ipdus

Parker Hannifin Corporation

Instrumentation Products Division
2651 Alabama Highway 21 North
Jacksonville, AL 36265-9681
USA
phone 256 435 2130
fax 256 435 7718
www.parker.com/ipdus

Parker Hannifin Corporation

Instrumentation Products Division
Autoclave Engineers Operation
8325 Hessinger Drive
Erie, PA 16509-4679
USA
phone 814 860 5700
fax 814 838 5811
<http://www.autoclave.com>

Parker Hannifin plc

Instrumentation Products Division
Riverside Road
Pottington Business Park
Barnstaple, Devon EX31 1NP
England
phone +44 0 1271 313131
fax +44 0 1271 373636
email ipd@parker.com
www.parker.com/ipd

Bulletin 4200-B4 M May 2014

Parker Hannifin Corporation
Instrumentation Products Division
1005 A Cleaner Way
Huntsville, AL 35805
phone 256 881 2040
fax 256 881 5072
www.parker.com/ipdus



Your Local Authorized Parker Distributor