



Spring Return

Automated Ball Valve Package

Series 88
3-Piece Ball Valve

Direct Mount

Full Port Valve

1500 & 2000 psi

1/2"-2"

316SS Body, Ball & Stem

Bellville Washers, Double Chevron Packing, RTFE Seats

Threaded, SW or BW



Direct Mount

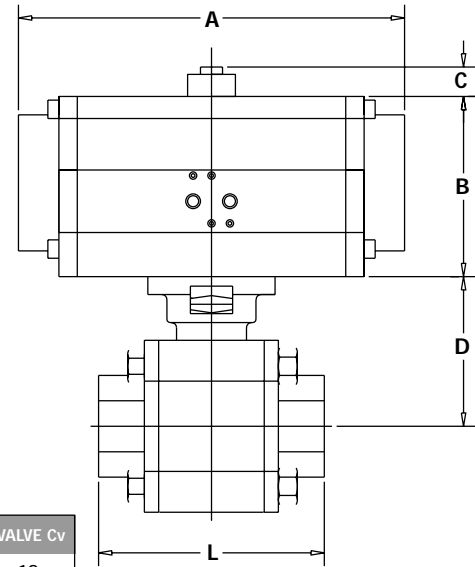

SERIES 88 Direct Mount

VALVE SIZE	A	B	C	D	L	VALVE Cv
1/2"	7.56	3.39	0.79	1.54	2.85	12
3/4"	8.94	4.45	0.79	1.70	3.36	32
1"	8.94	4.45	0.79	2.32	4.14	56
1-1/4"	8.94	4.45	0.79	2.46	4.35	85
1-1/2"	8.94	4.45	0.79	2.80	4.97	125
2"	10.39	4.88	0.79	3.43	5.61	240

SIZED FOR 80 psi AIR SUPPLY	
SIZE	MODEL
1/2"	88-TX-050/TR2S-XX
3/4"	88-TX-075/TR3S-XX
1"	88-TX-100/TR3S-XX
1-1/4"	88-TX-125/TR3S-XX
1-1/2"	88-TX-150/TR3S-XX
2"	88-TX-200/TR4S-XX

SIZED FOR 60 psi AIR SUPPLY	
SIZE	MODEL
1/2"	88-TX-050/TR2S-XX
3/4"	88-TX-075/TR3S-XX
1"	88-TX-100/TR3S-XX
1-1/4"	88-TX-125/TR3S-XX
1-1/2"	88-TX-150/TR4S-XX
2"	88-TX-200/TR4S-XX

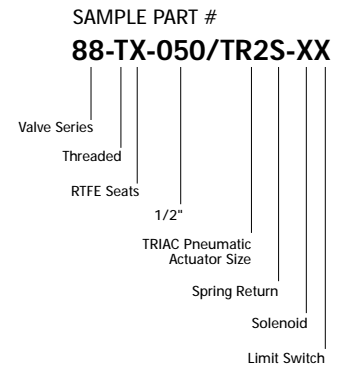

OPTIONS

DESCRIPTION	PART NO. SUFFIX	DESCRIPTION	PART NO. SUFFIX
NEMA 4 Solenoid	(A)	NEMA 4 Limit Switch (2) spdt	(A)
NEMA 7 Solenoid	(B)	NEMA 7 Limit Switch (2) spdt	(B)

Other options available - call for details

Actuators are sized based on clean/clear fluid at full rated pressure of valves.



Series 88

Heavy Duty, Full Port PN100 & PN125
 3-Piece Ball Valve 1500 & 2000 psi wog
 ISO 5211 Direct Mount 1/2" (DN 15) to 2" (DN50)

Pressure vs. Temperature Chart
 for Valve 1/4" (DN8) to 1"(DN25)

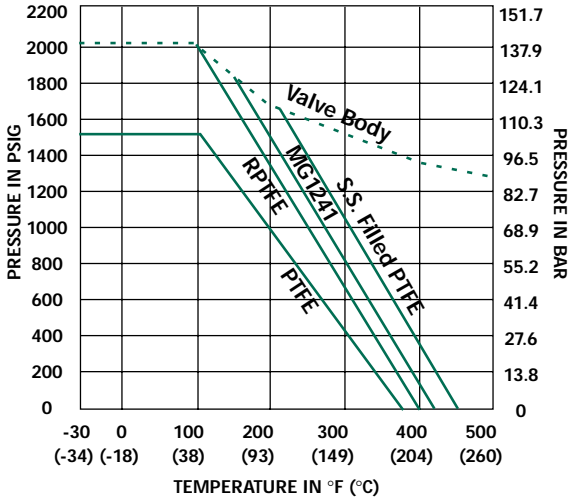

Pressure vs. Temperature Chart
 for Valve 1-1/4" (DN32) to 2"(DN50)

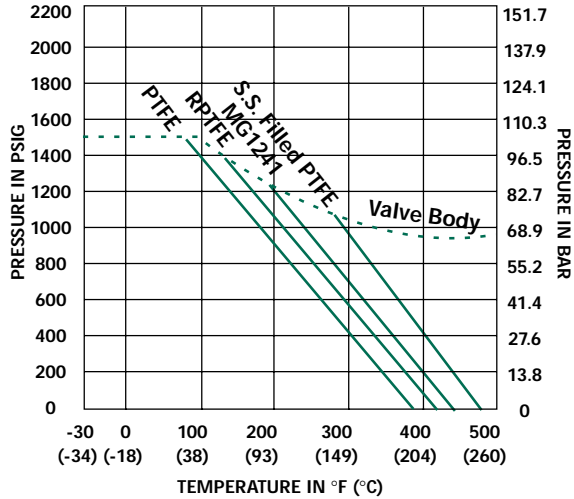

NOTE: Dotted line shows the rating for valve body. Solid line shows the rating for valve seat. Both ratings need to be consulted when determining the limitation of the valve for specific application.

MATERIALS LIST

NO.	PART NAME	MATERIAL	QTY.
1	Body	ASTM A351 Gr. CF8M	1
2	End Cap	ASTM A351 Gr. CF8M	2
3	Ball	SUS 316	1
4	Stem	SUS 316	1
5	Stem Nut	SUS 304	2
6	Belleville Washer	SUS 301	2
7	Handle	SUS 304	1
8	Seat	RPTFE	2
9	Gland	SUS 304	1
10	V-Shaped Packing	MG1241	§
11	Stem Seal	RPTFE	1
12	Lock Saddle	SUS 304	1
13	Joint Gasket	PTFE	2
14	Bolt	SUS 304	*
15	Stop Bolt & Nut	SUS 304	1
16	Handle Sleeve	Vinyl	1
17	Bolt Nut	SUS 304	†
18	Stem Washer	SUS 304	1
19	Bushing	‡	1
20	Locking Device	SUS 304	1

§ 1 set of v-ring packing consists of 2 pcs. of v-ring
 * For 1/2" to 1-1/2" - 4 pcs.; For 2" - 6 pcs.
 † For 1/2" to 1-1/2" - 4 pcs; For 2" - 6 pcs
 ‡ 50% stainless steel powder filled PTFE

NOTE: Materials designated in the material list are our standard materials. Other options are available for higher pressure and temperature rating (see pressure vs. temperature chart for different seat options).

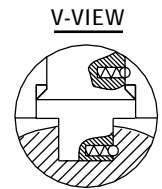
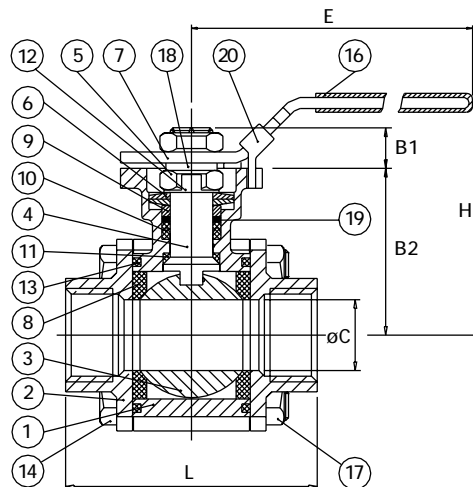
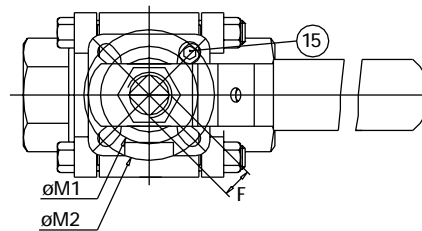

Pyramidal Stem & Anti-Static Device

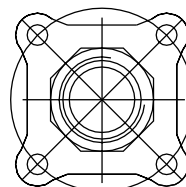

1/2" - 1-1/2"

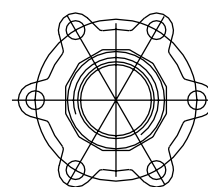

2"



Division of A-T Controls
 11363 Deerfield Rd.
 Cincinnati, Ohio 45242

(513) 247-5465
 FAX (513) 247-5462